

Rz3.2

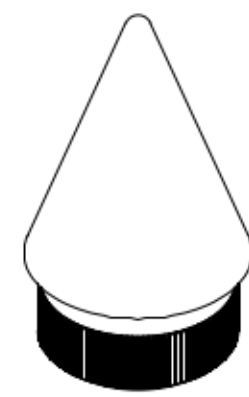
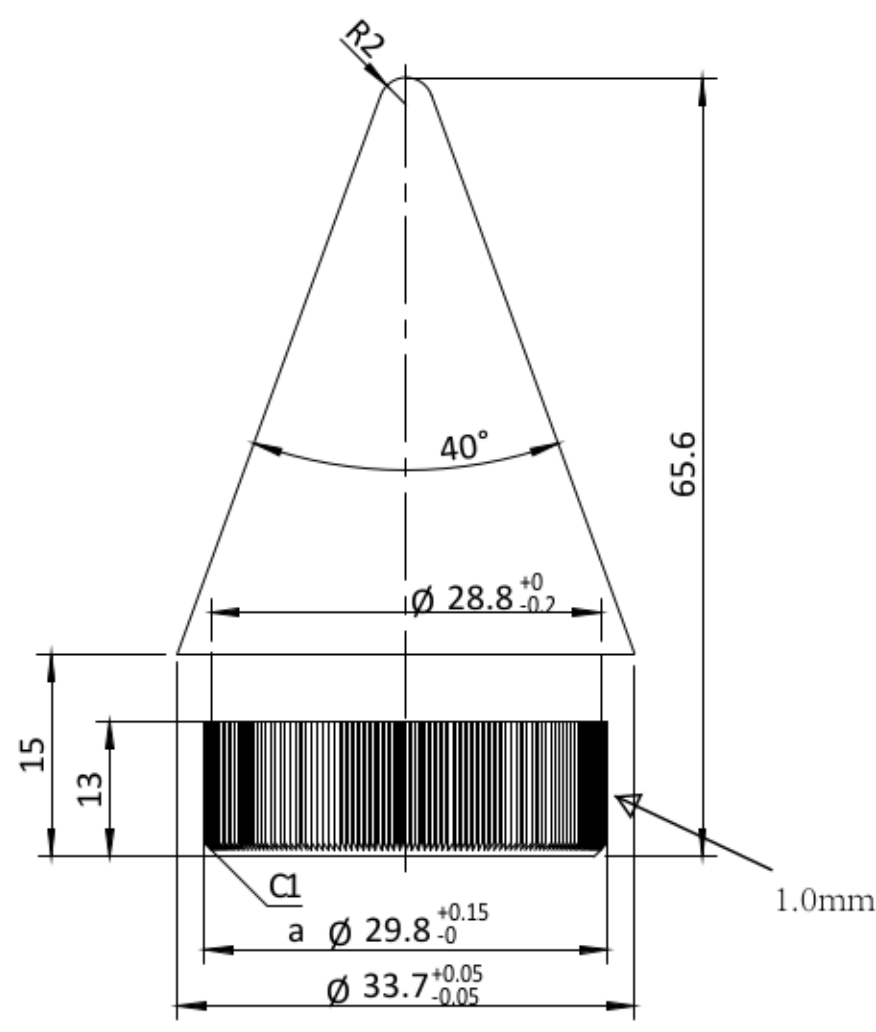

100.7424		2:1	A2
		SS304	
		0.19kg	