

Rz3.2

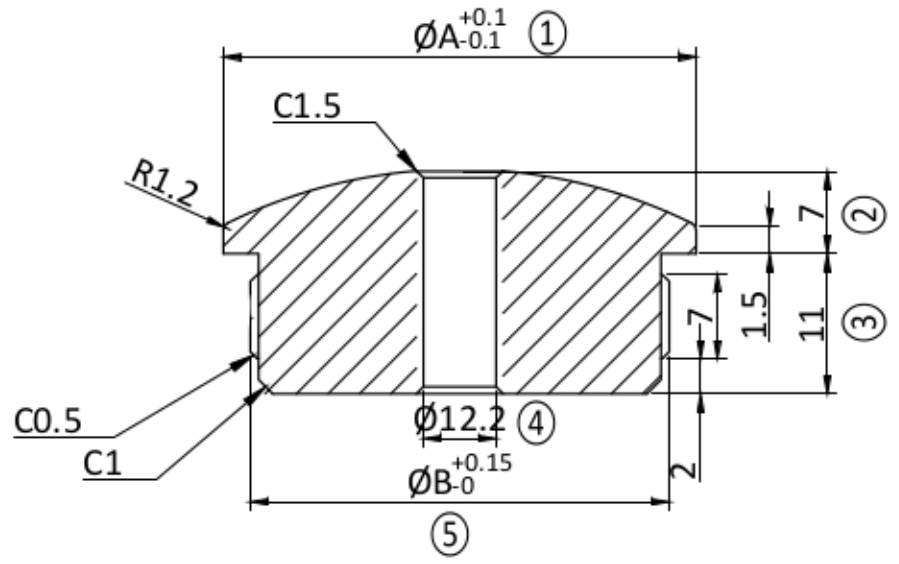

		tubeØ	A	B
	100.7150	Ø42.4X2.0	Ø42.4	38.7
	100.7145	Ø33.7X2.0	Ø33.7	30

		2:1	A1
		SS304	
			2018.3.6