

√ Rz3.2

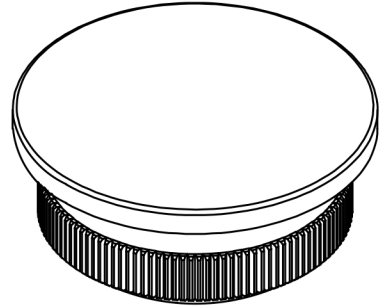
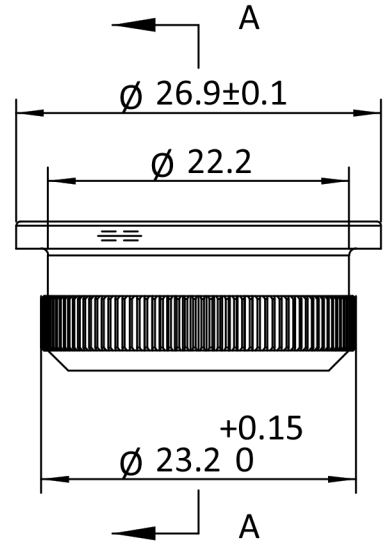
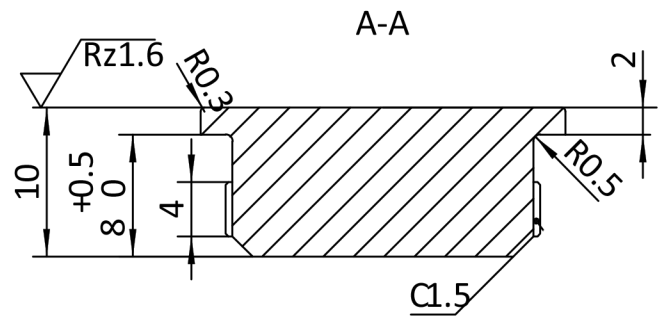

100.6975		2:1	A0
		SS304	
		36g	2019.10.28