

Rz3.2

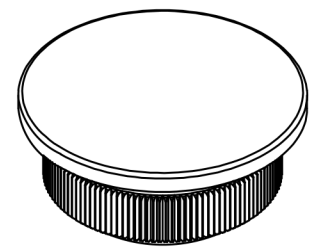
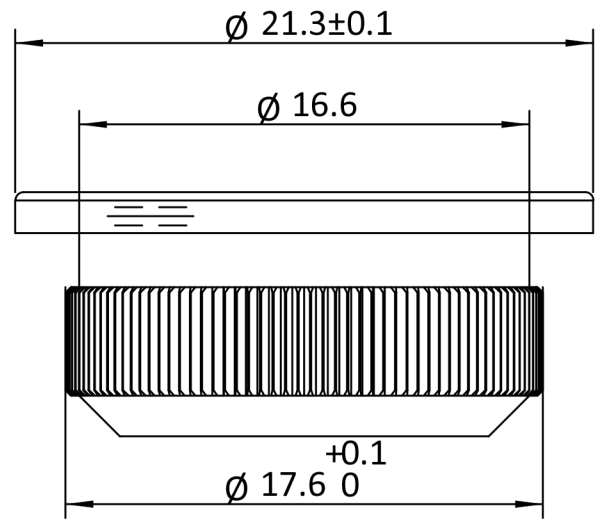

100.6970		4:1	A0
		SS304	
		17g	2019.10.28