

Rz3.2

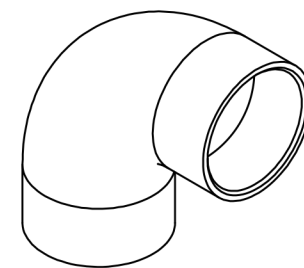
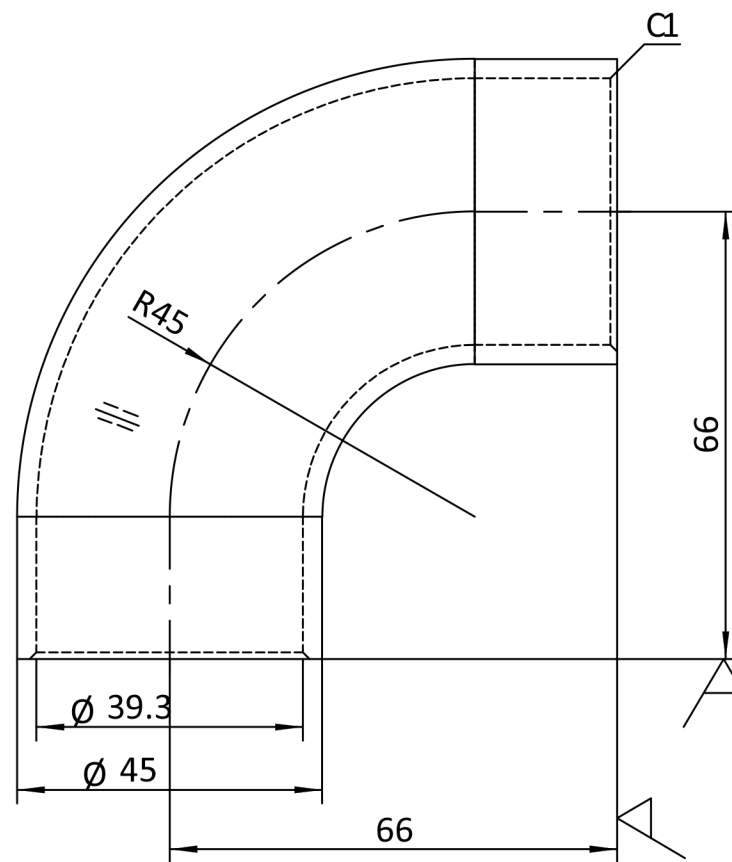

100.6365		1:1	A0
		SS304	
		0.34kg	2019.10.25