

Rz3.2

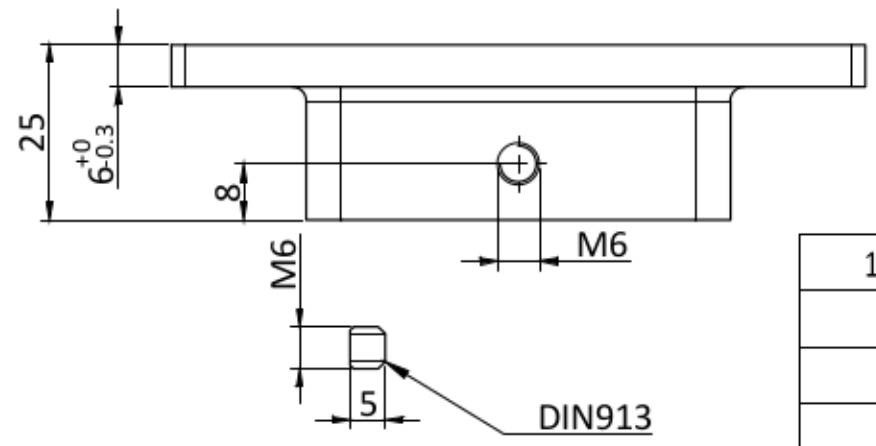
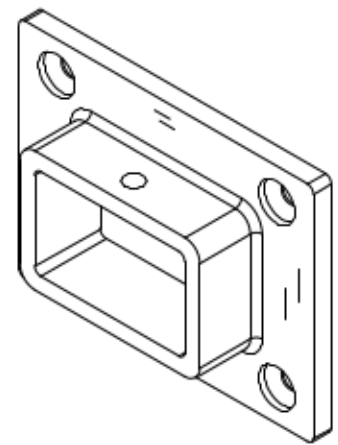

100.6220		1:1	A0
		SS316	