

Rz3.2

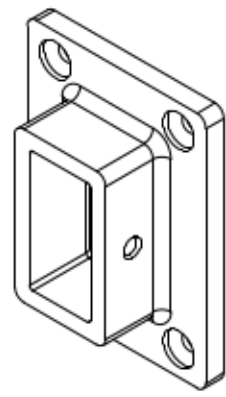
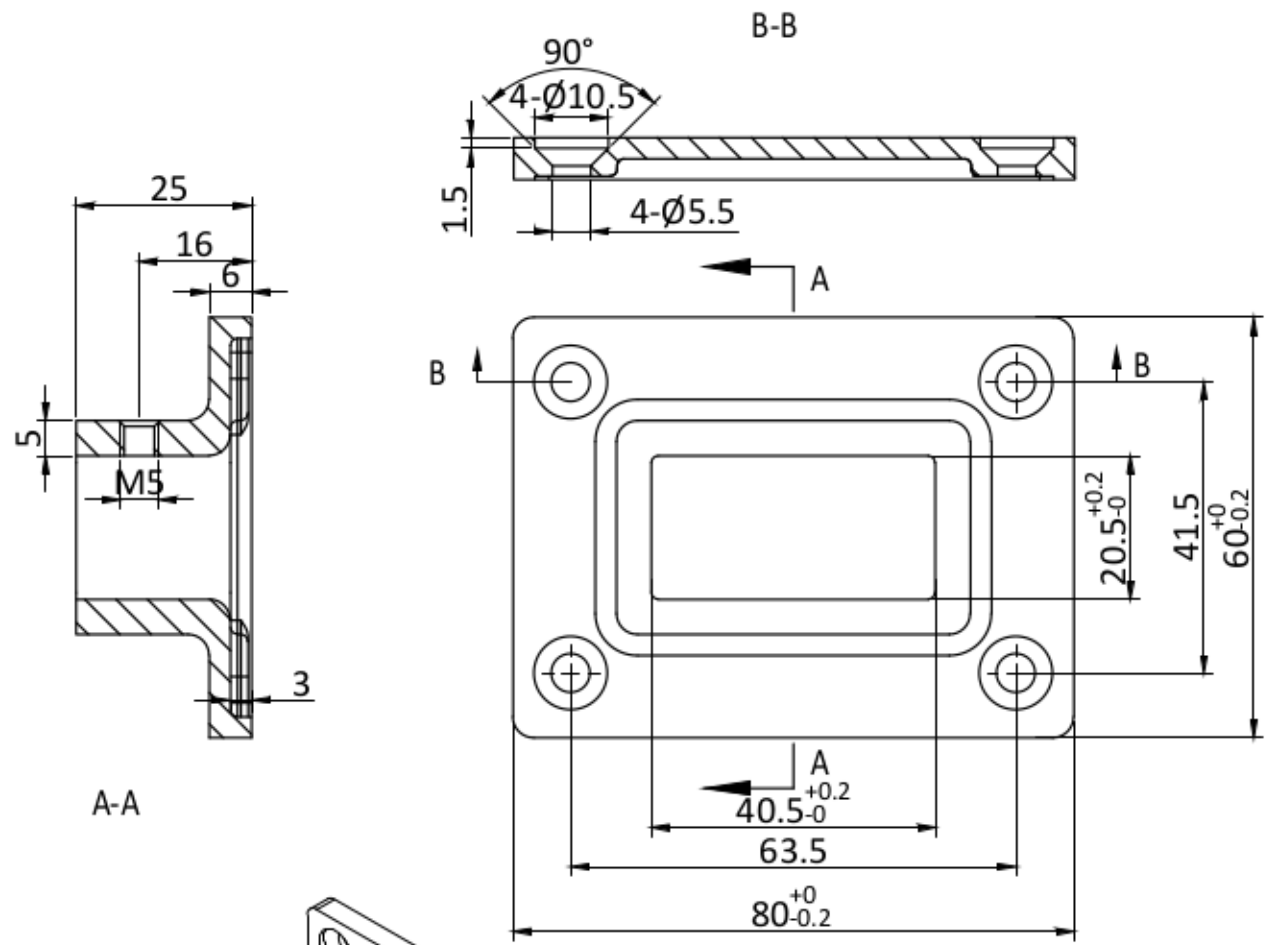

100.6200		1:1	A0
		SS316	