

Rz3.2

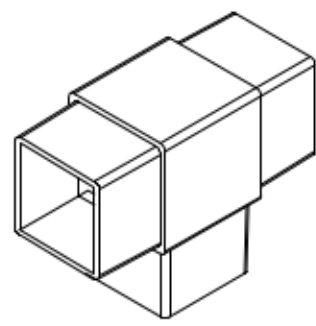
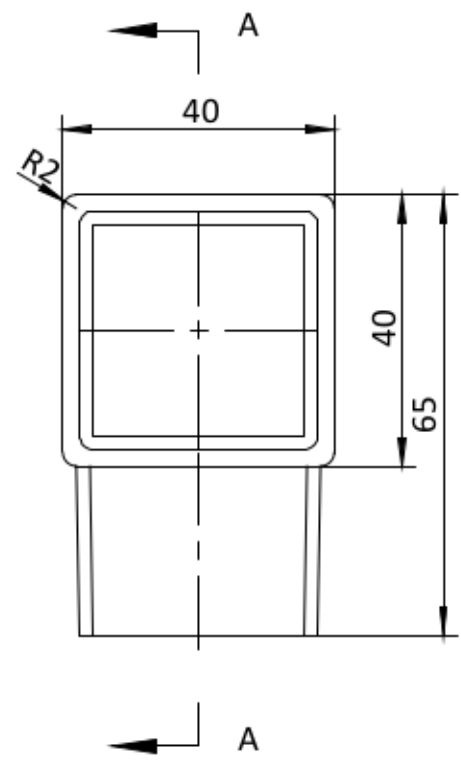
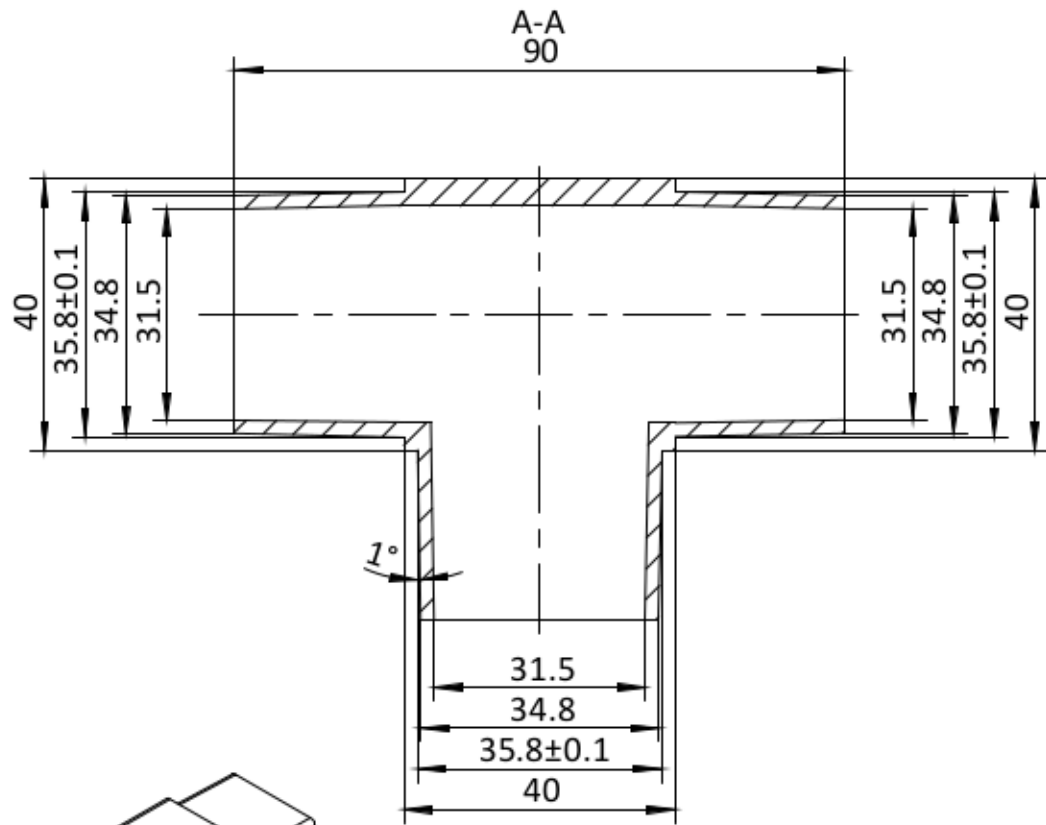

100.6105		1:1	A0
		SS316	
		0.31KG	