

Rz3.2

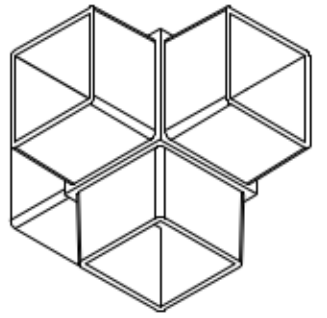
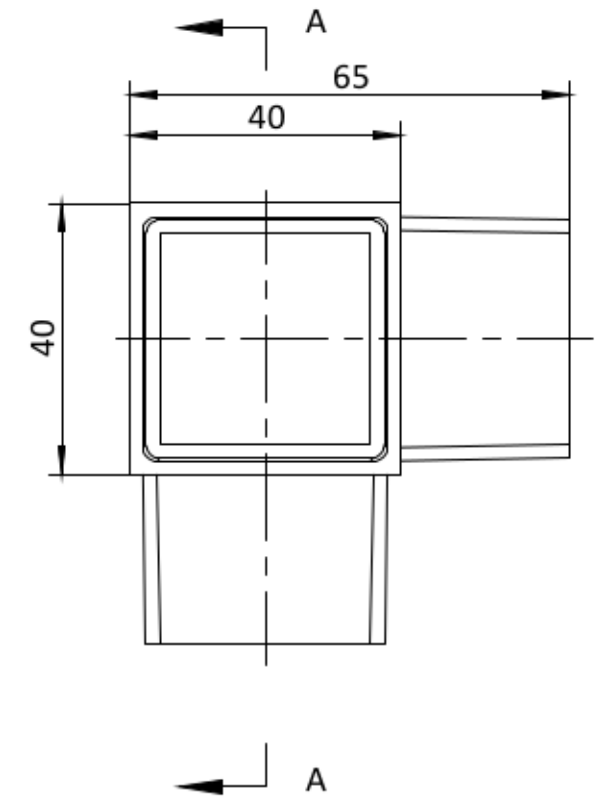
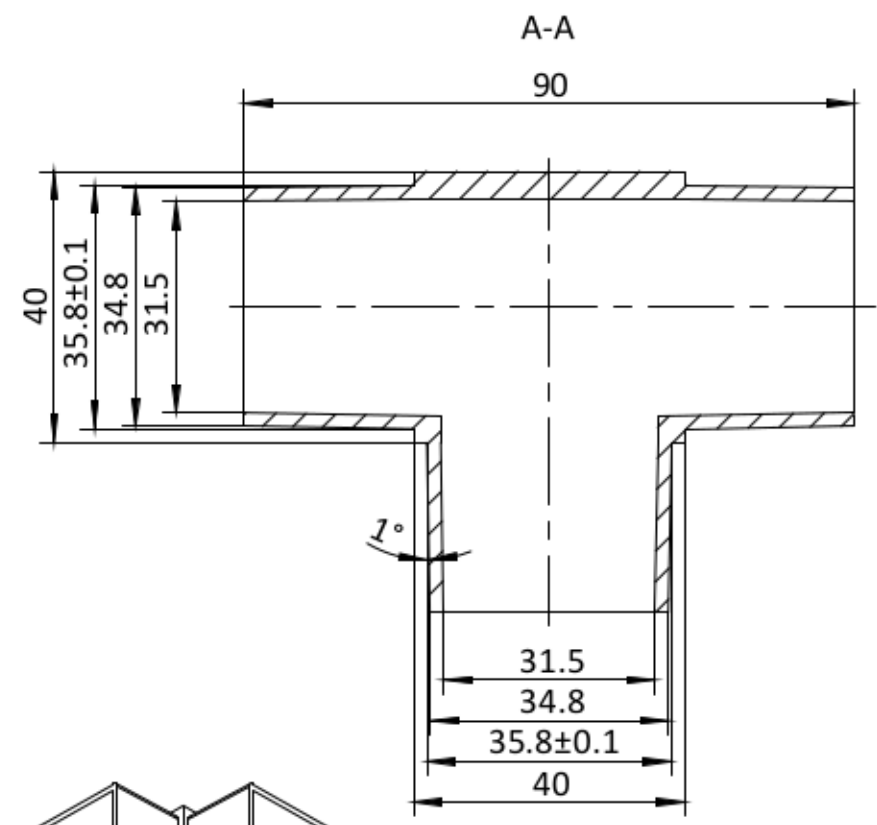

100.6055		1:1	A0
		SS304	
		0.33KG	