

A-A

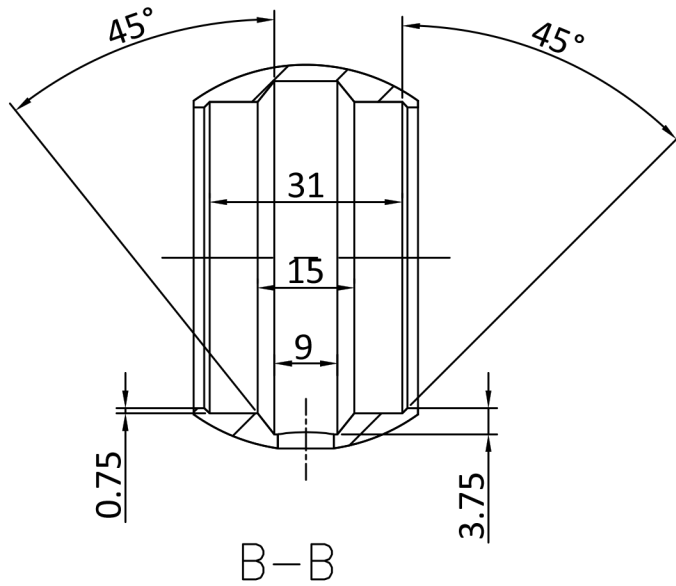

100.5937		1:1	A0
		SS304	
			2017.11.1