

A-A

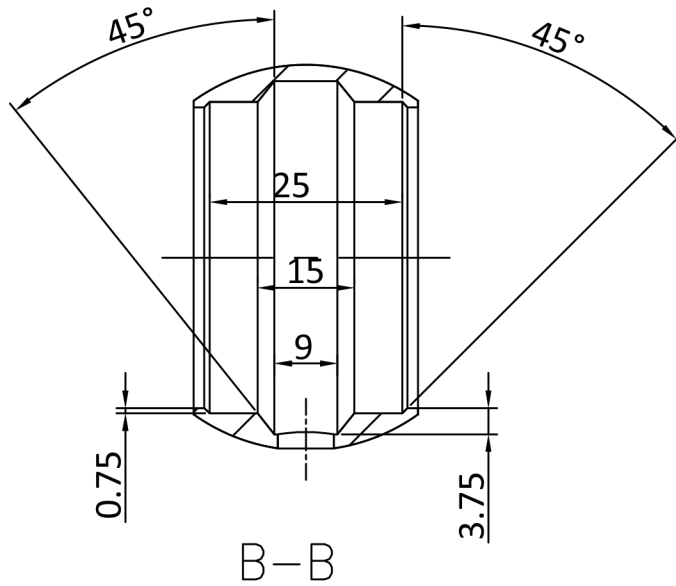

100.5930		1:1	A1
		SS304	
			2017.11.7