

Rz3.2

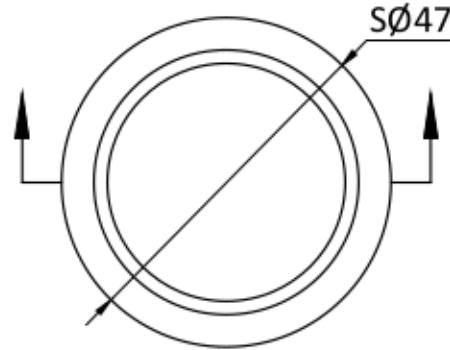
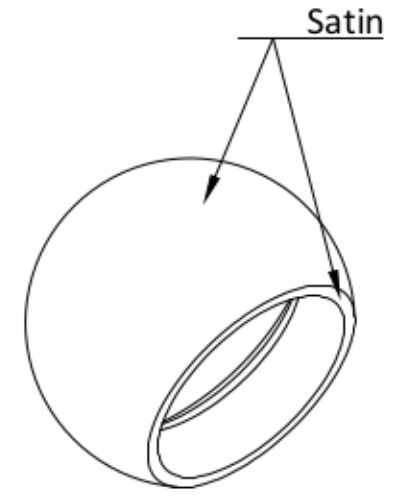
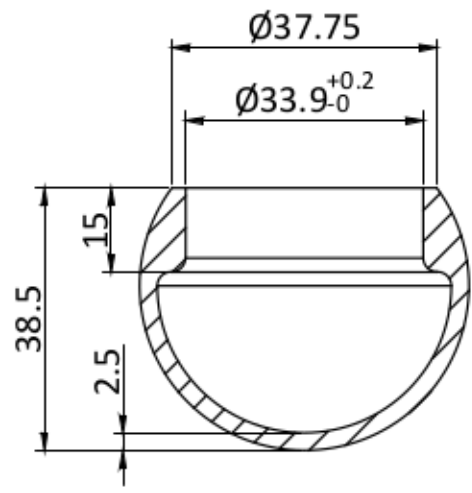

100.5875		1:1	A1
		SS316	