

Rz3.2

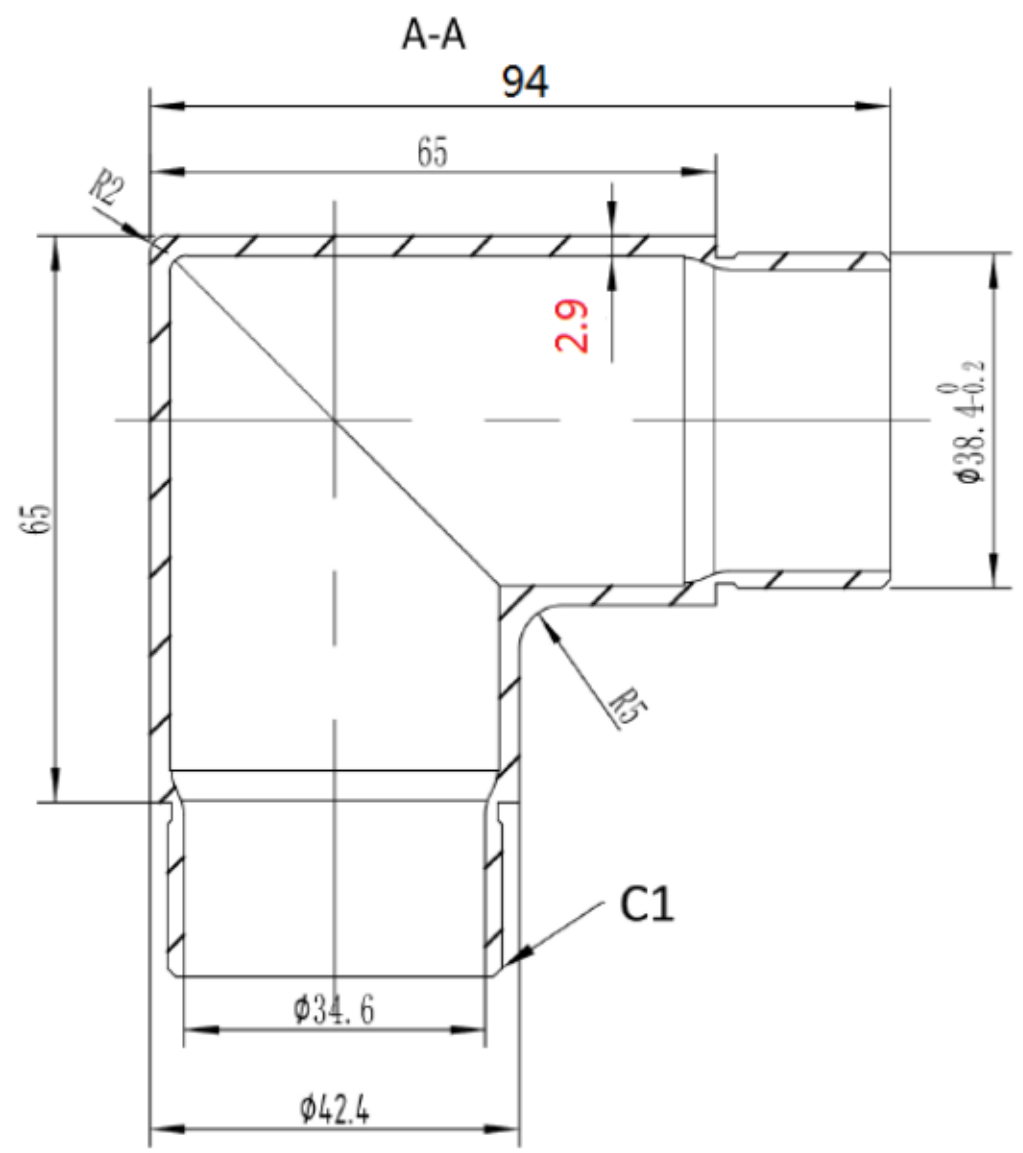
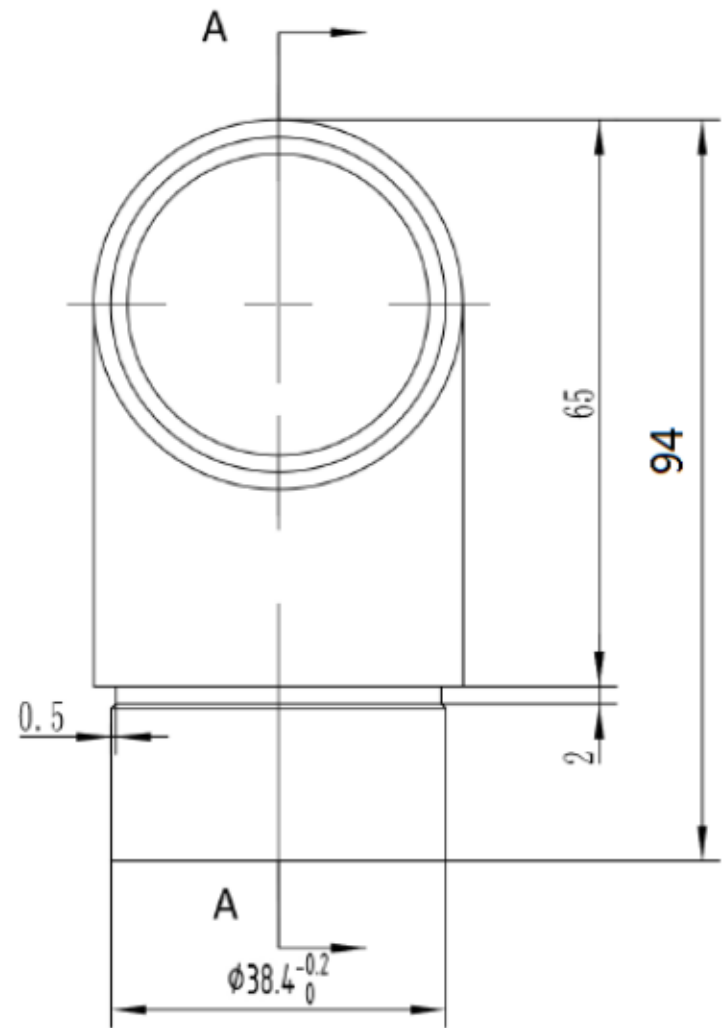

100.5680		1:1	
		SS304	