

▽ Rz3.2

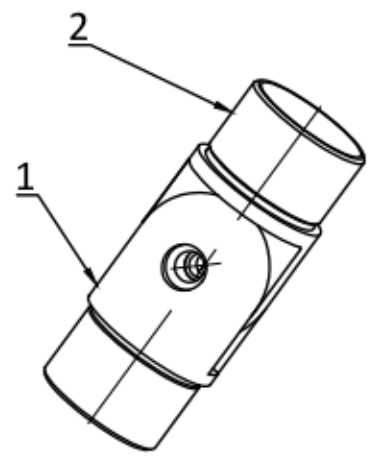

2			1	
1			1	
100.5515			1:1	A0
			SS316	

▽ Rz3.2

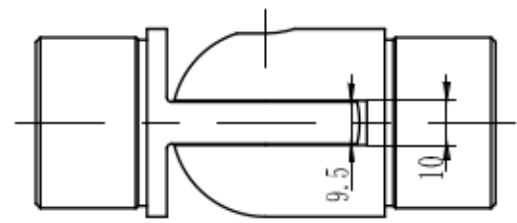
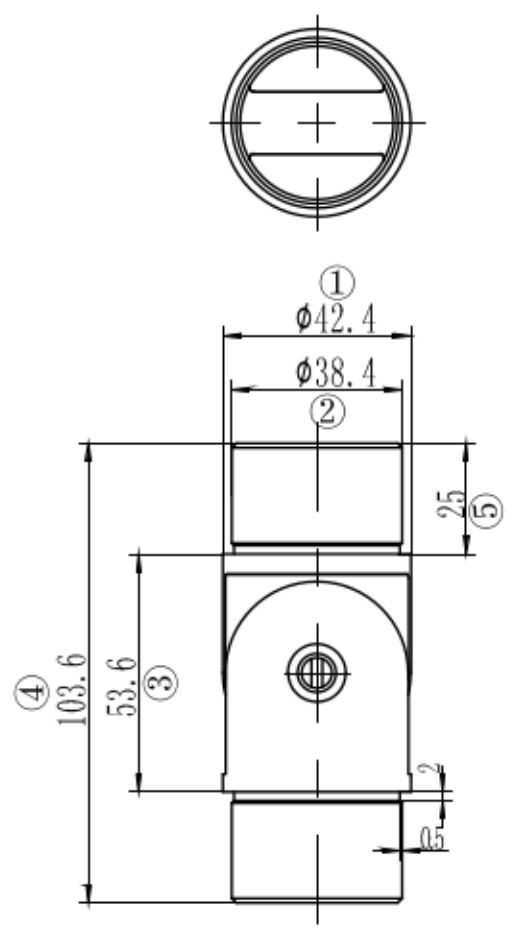
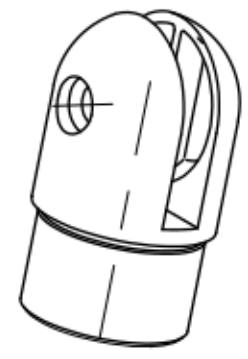
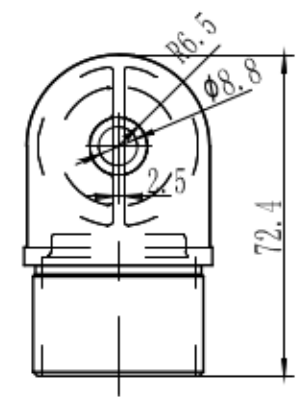
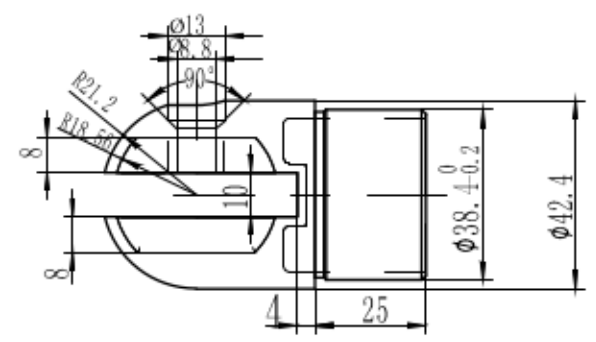
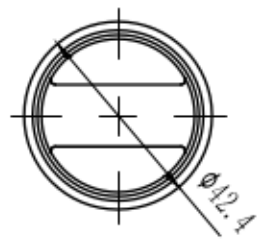

100.5515		1:1	
		SS316	

▽ Rz3.2

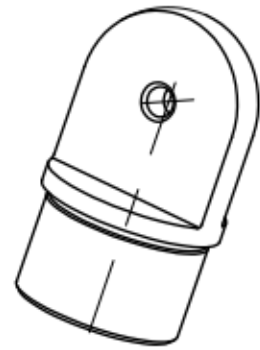
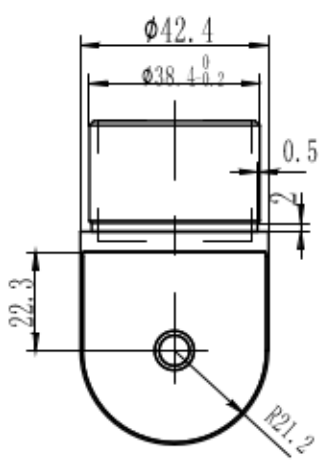
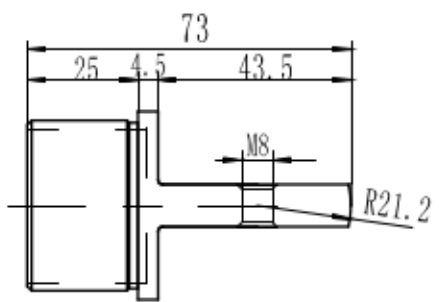
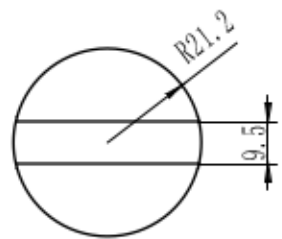

100.5515		1:1	
		SS316	