

Rz3.2

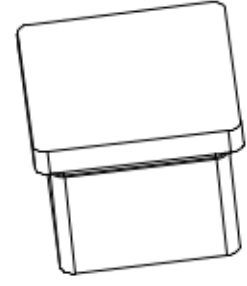
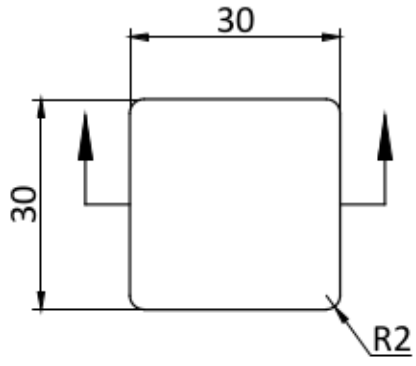
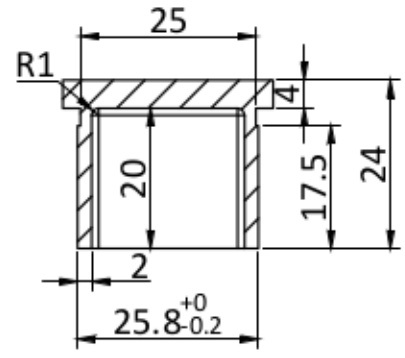

100.5425		1:1	A0
		SS304	
			2016.6.23
	60200.30.2		