

Rz3.2

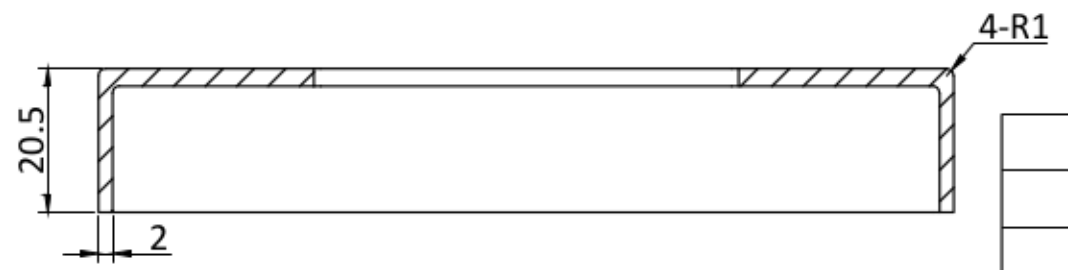
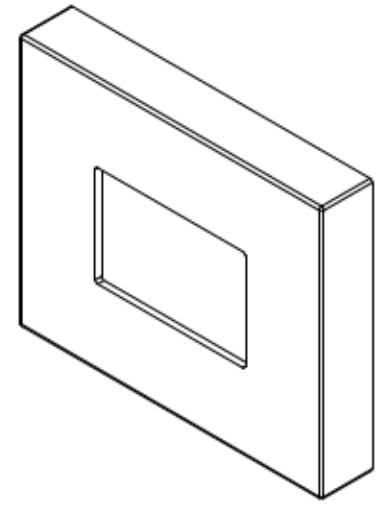
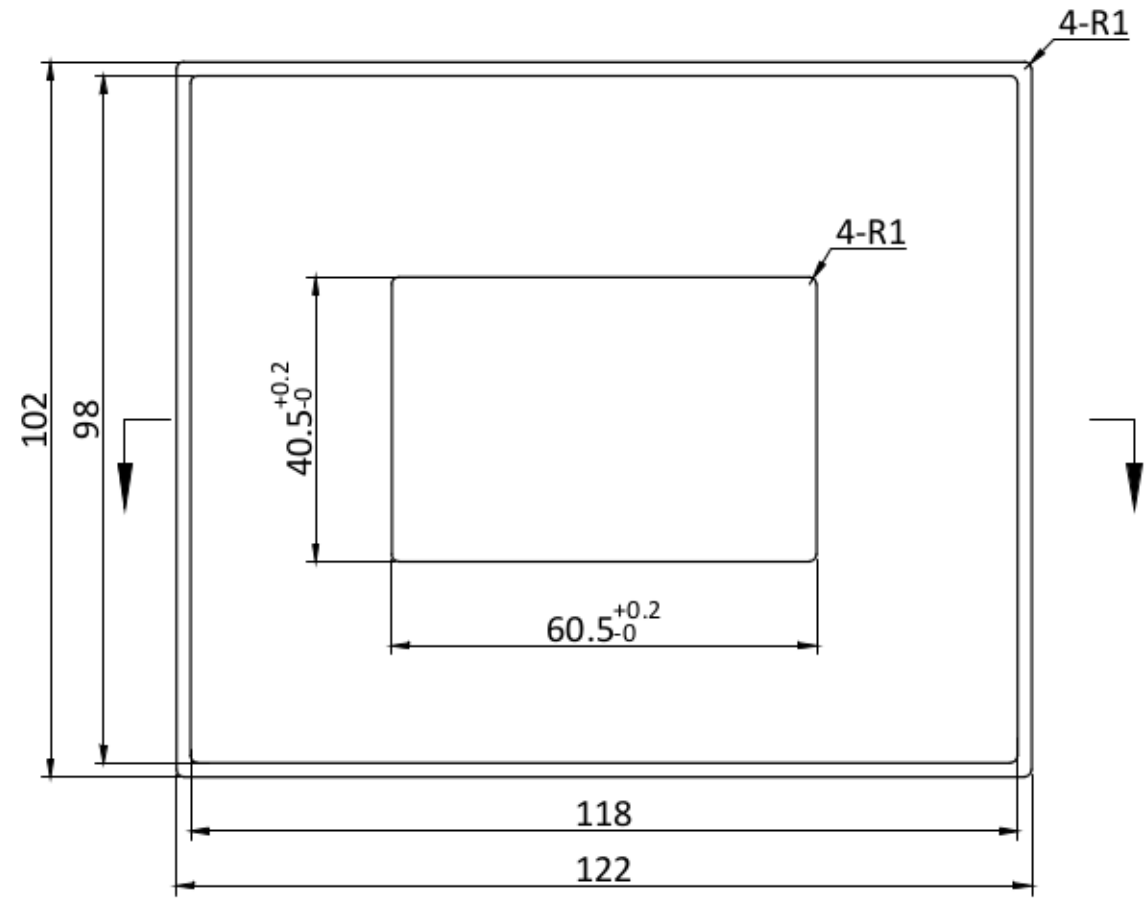

100.5225		1:1	A0
		SS316	