

√ RZ6.3

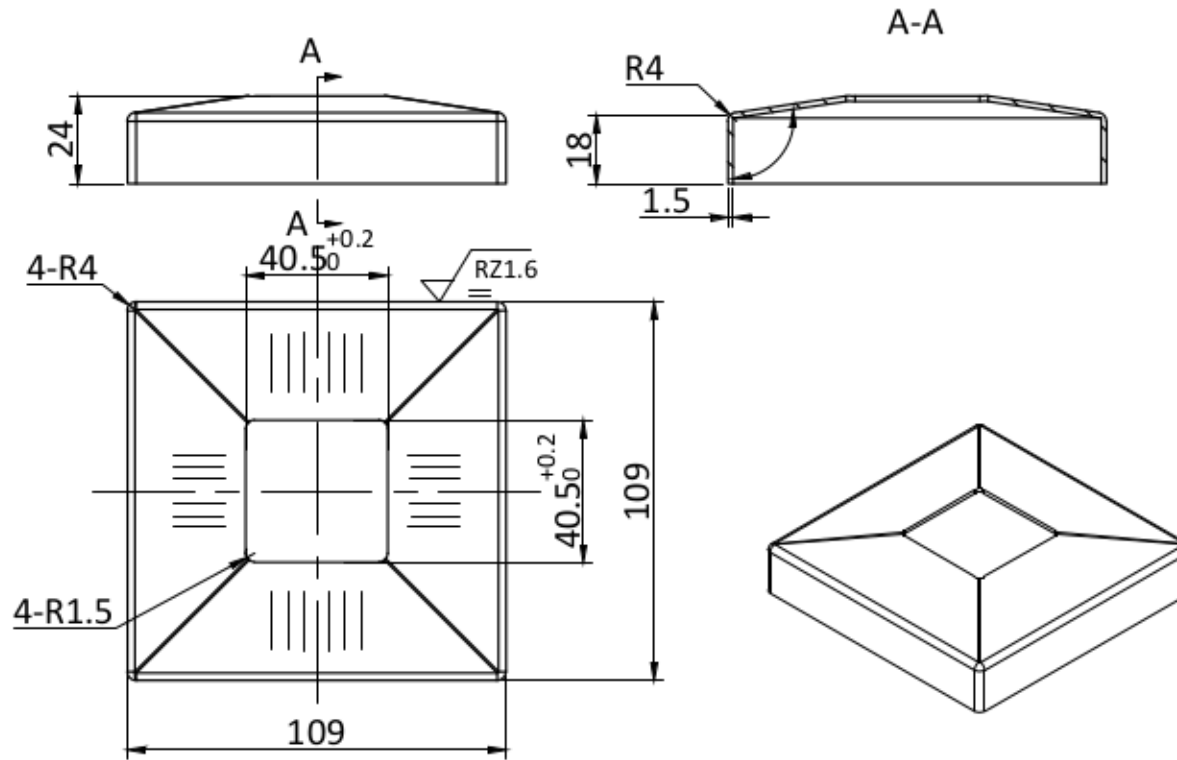

100.5220		1:2	A0
		SS304	