

Rz3.2

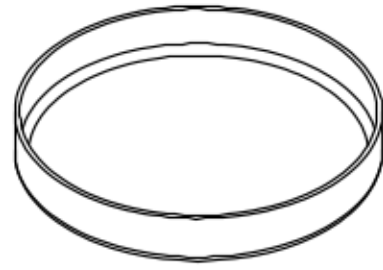
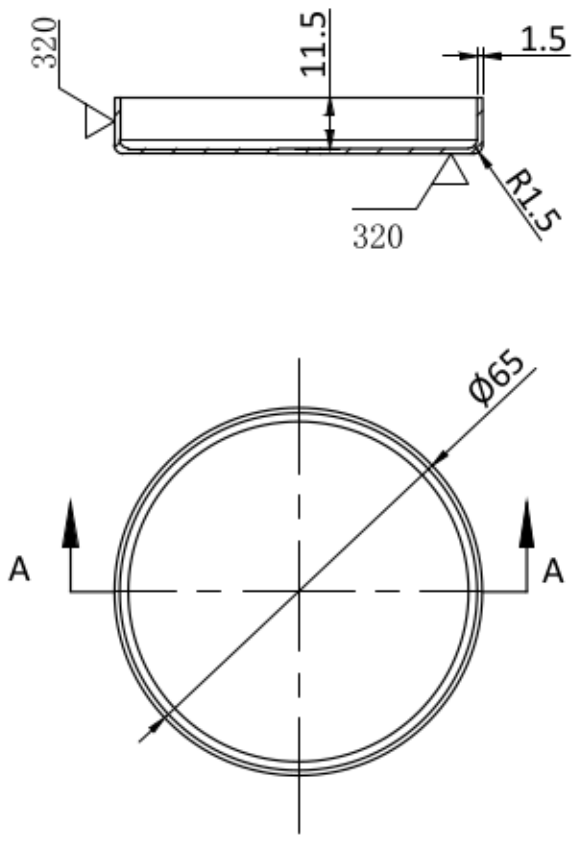

100.5165		1:2	A0
		SS304	