

Rz3.2

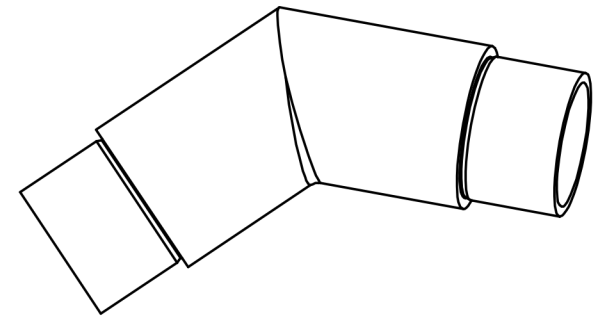
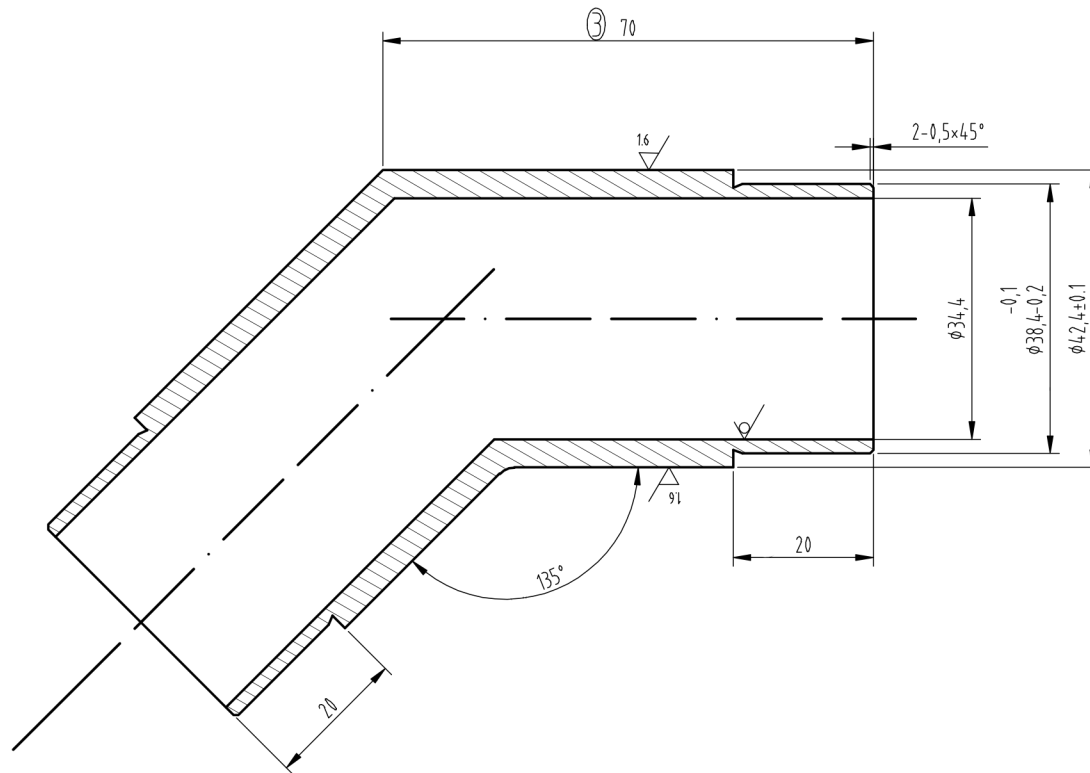

100.4305		1:1	A0
		SS316	
			2016.5.5
	52024.420.024		