

Rz3.2

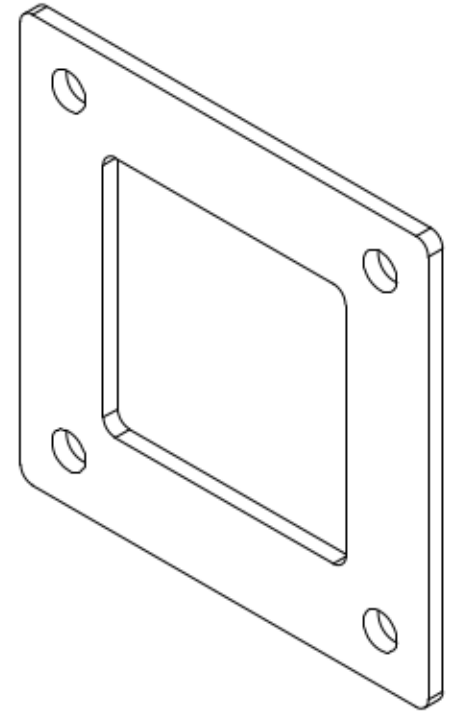
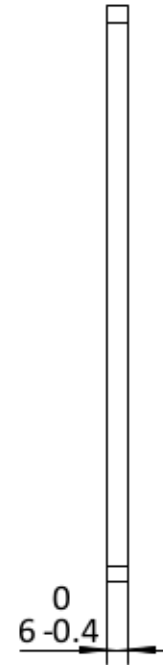

100.4021		1:2	A0
		SS304	
		0.86kg	