

Rz3.2

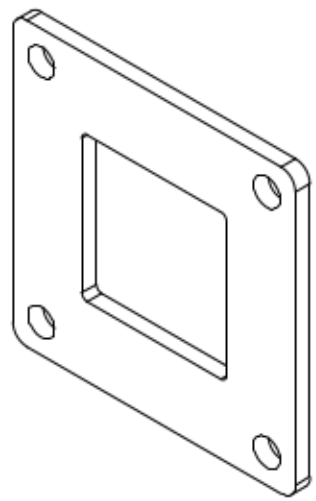

100.4015		1:1	A0
		SS304	
		0.47kg	