

Rz3.2

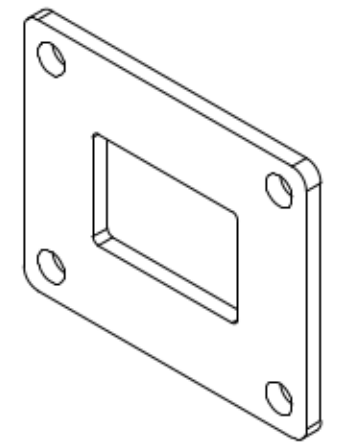
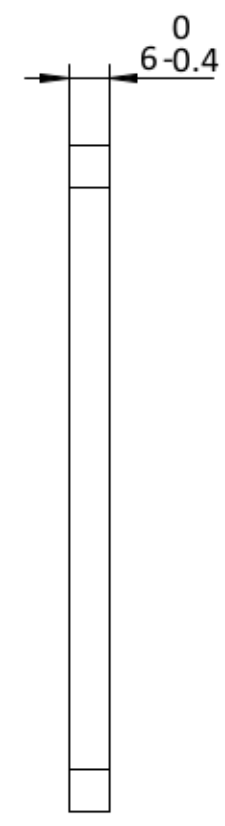
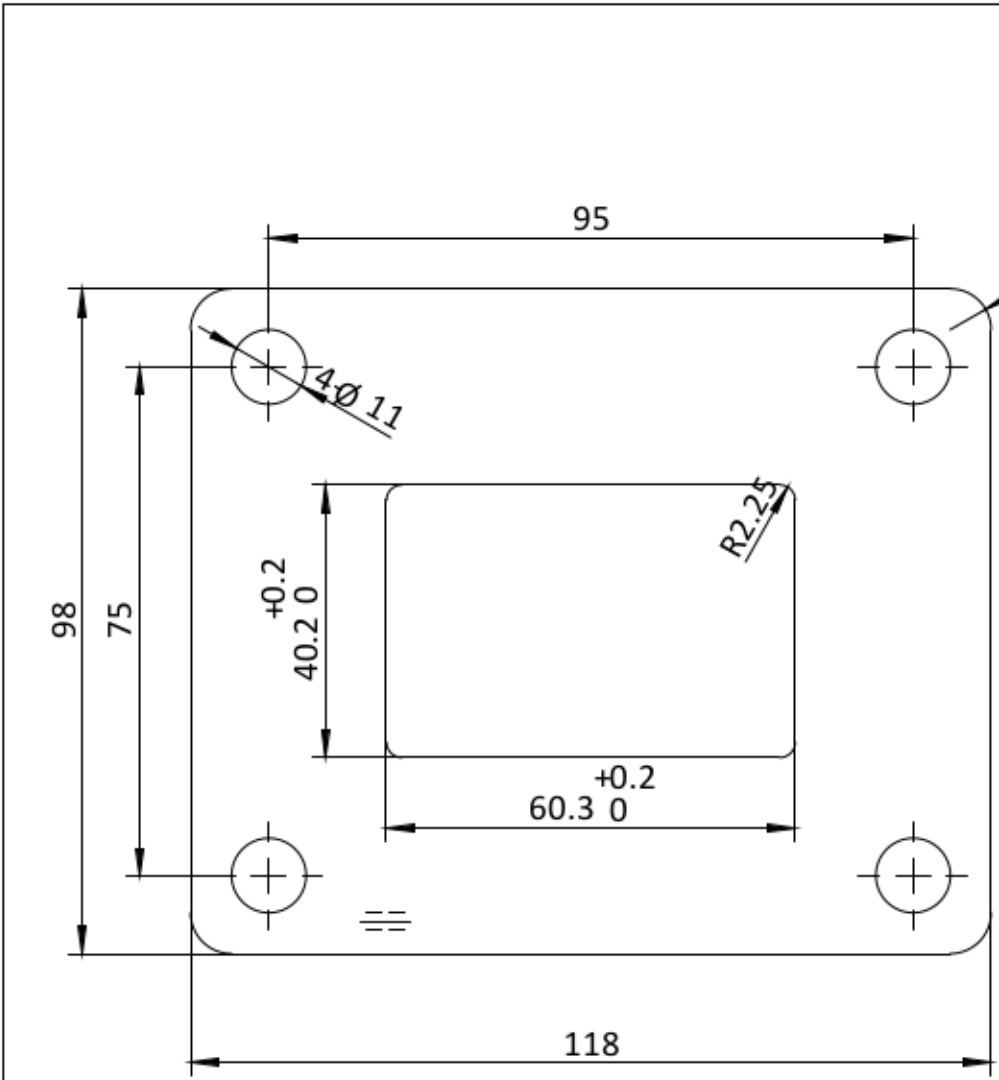

100.4010		1:1	A0
		SS304	
		0.41kg	