

Rz3.2

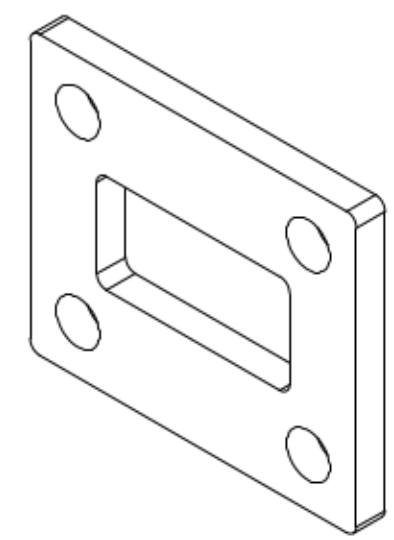
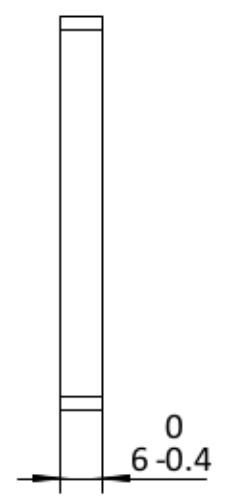
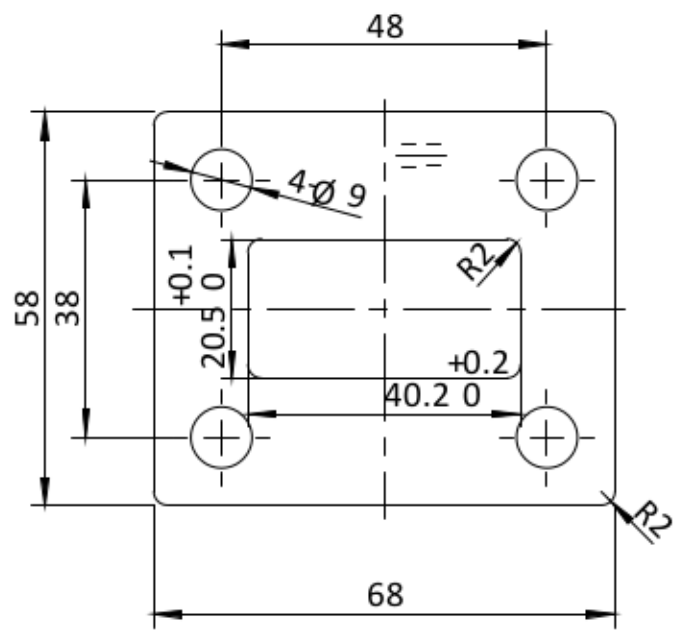

100.3995		1:1	A0
		SS304	
		0.14kg	