

Rz3.2

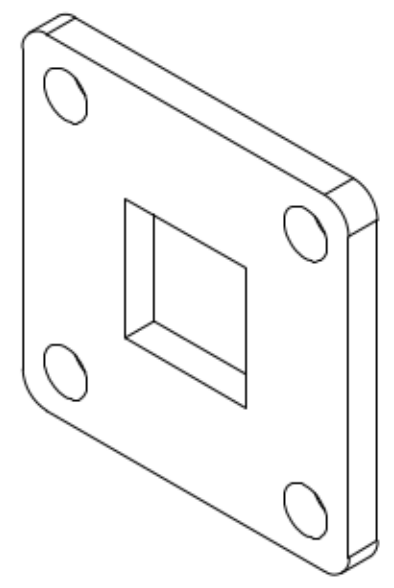
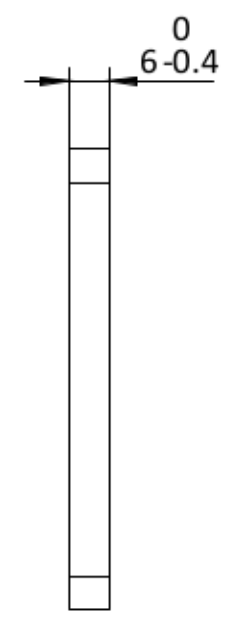
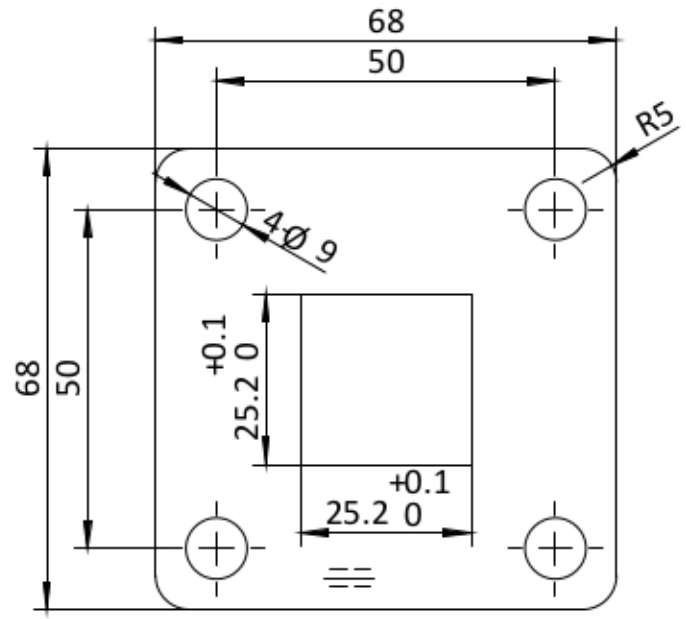

100.3980		1:1	A0
		SS304	
		0.18kg	