

Rz3.2

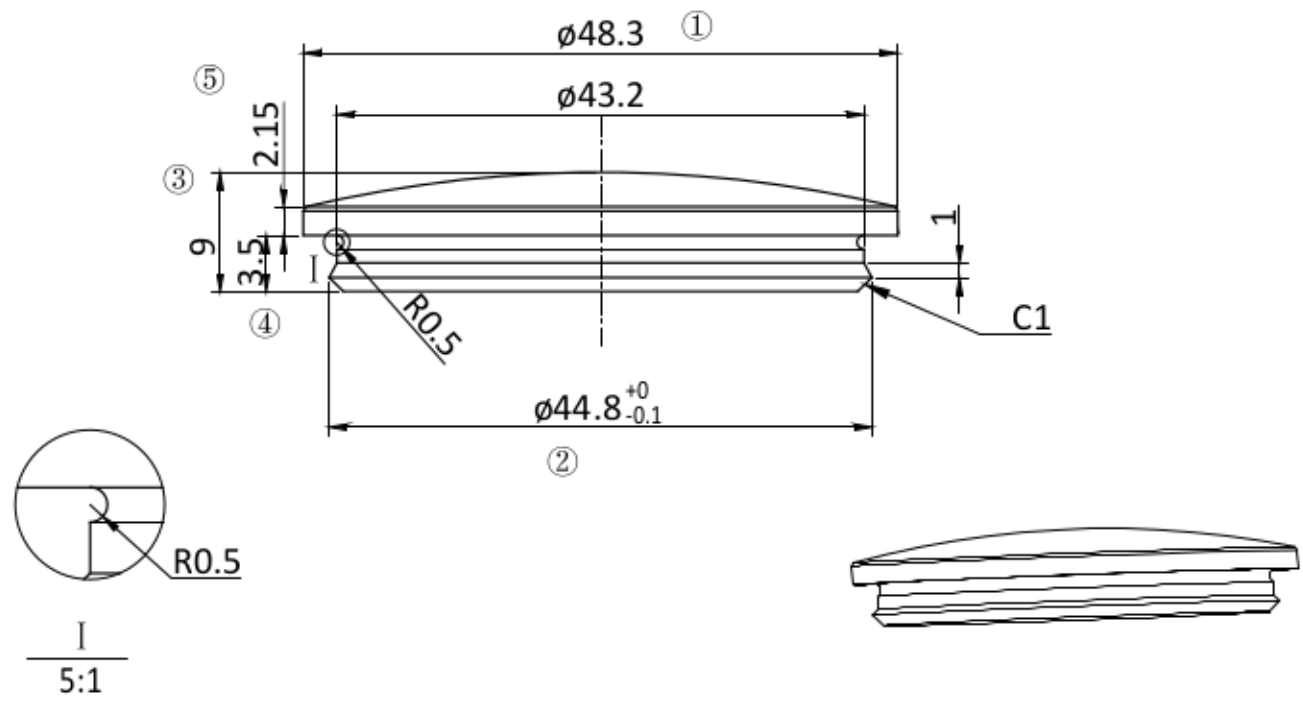

100.2520		2:1	A3
		SS304	