

Rz3.2

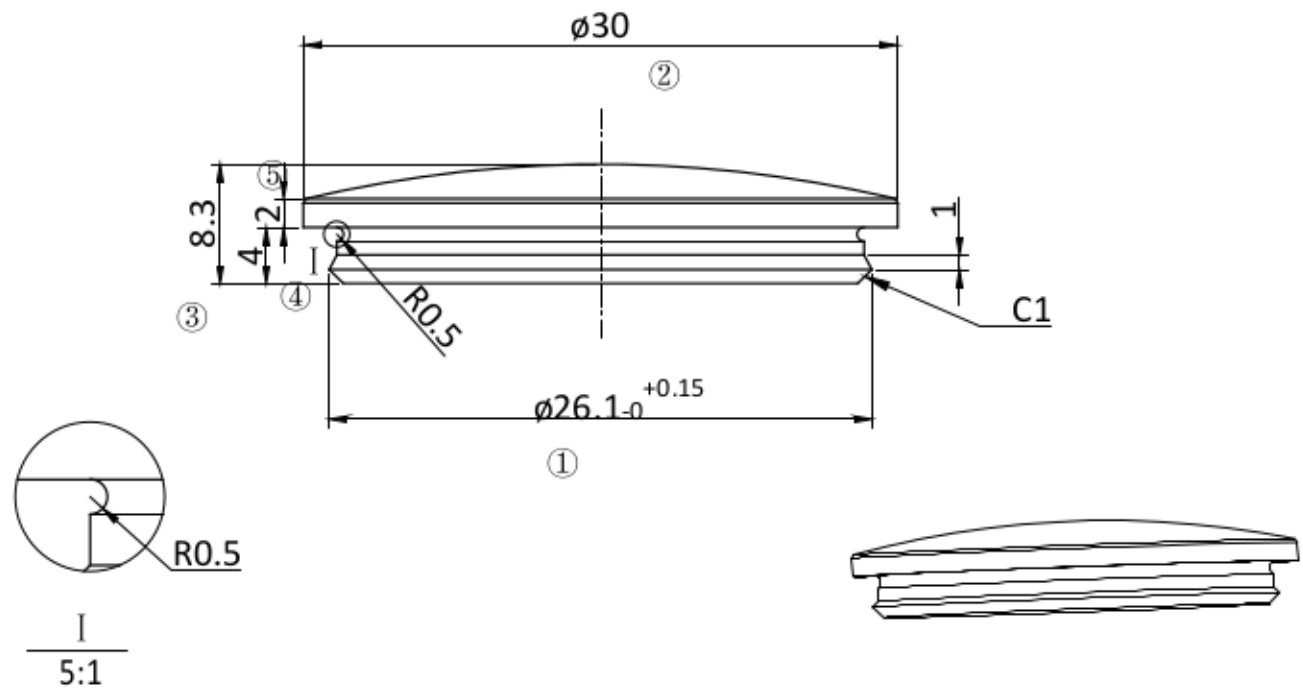

100.2500		2:1	A1
		SS304	