

Rz3.2

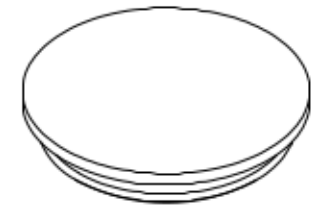
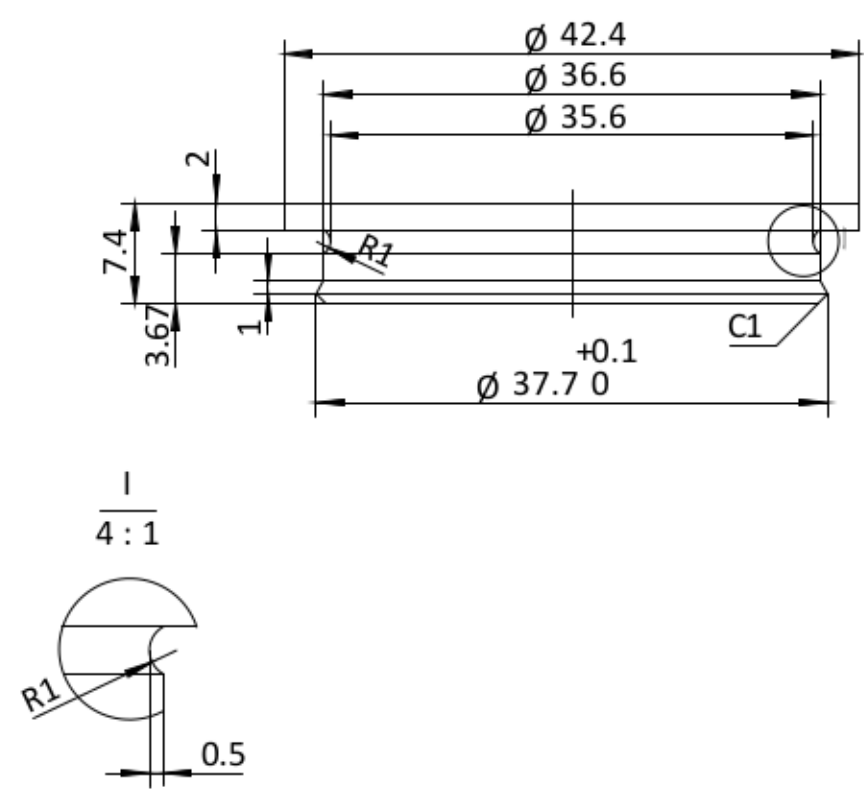

100.2470		2:1	A0
		SS304	
		0.07kg	