

Rz3.2

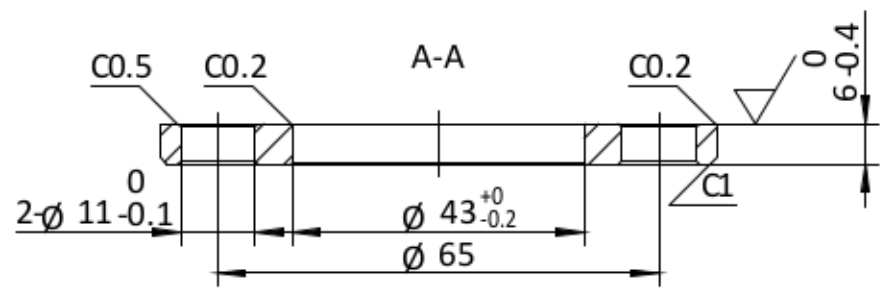
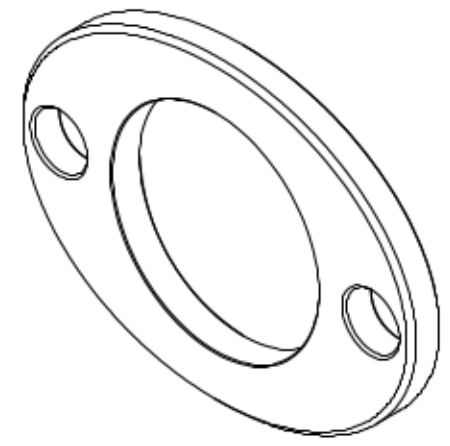
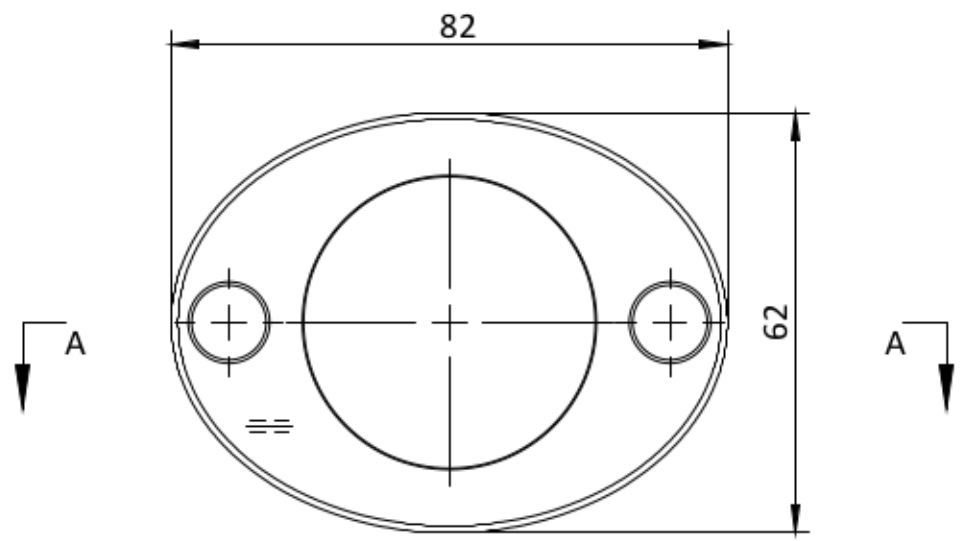

100.2315		1:1	A0
		SS304	
		0.11kg	
34082.6.012			