

Rz3.2

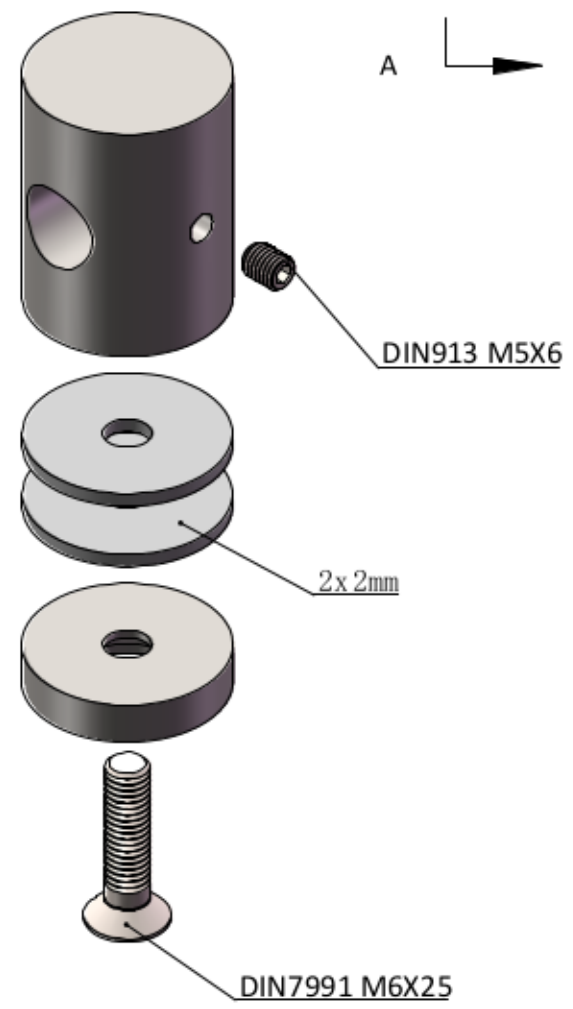
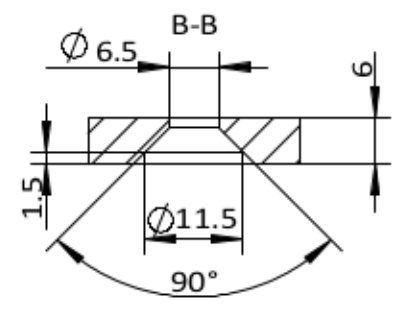
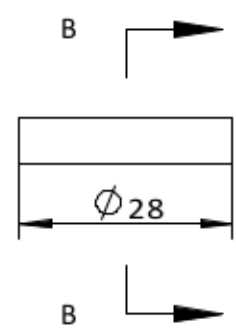
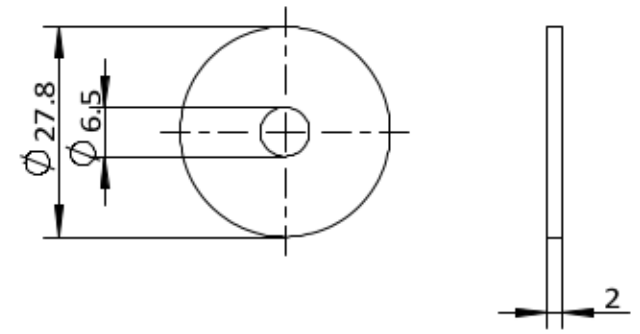
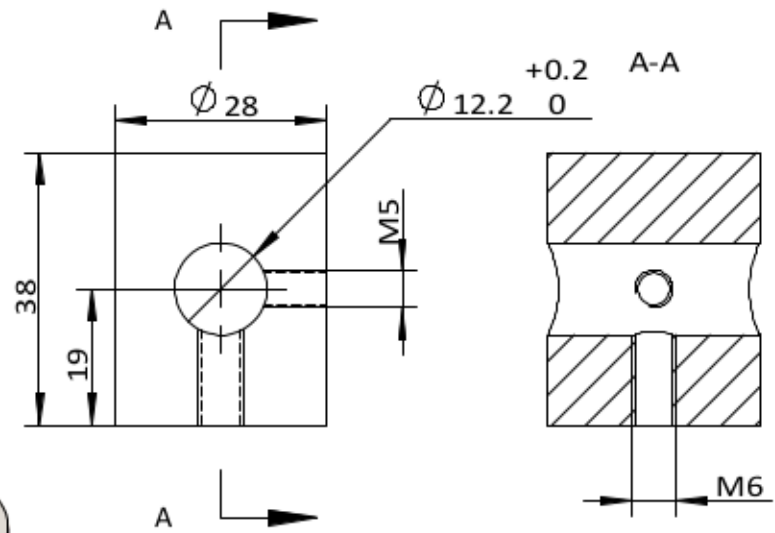

100.1410		1:1	A1
		SS304	
		0.177kg	2020.9.10