

Rz3.2

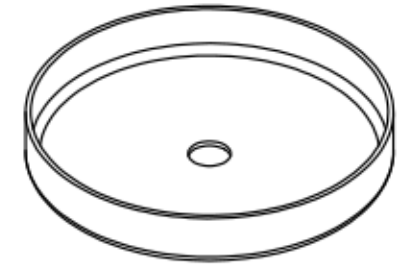
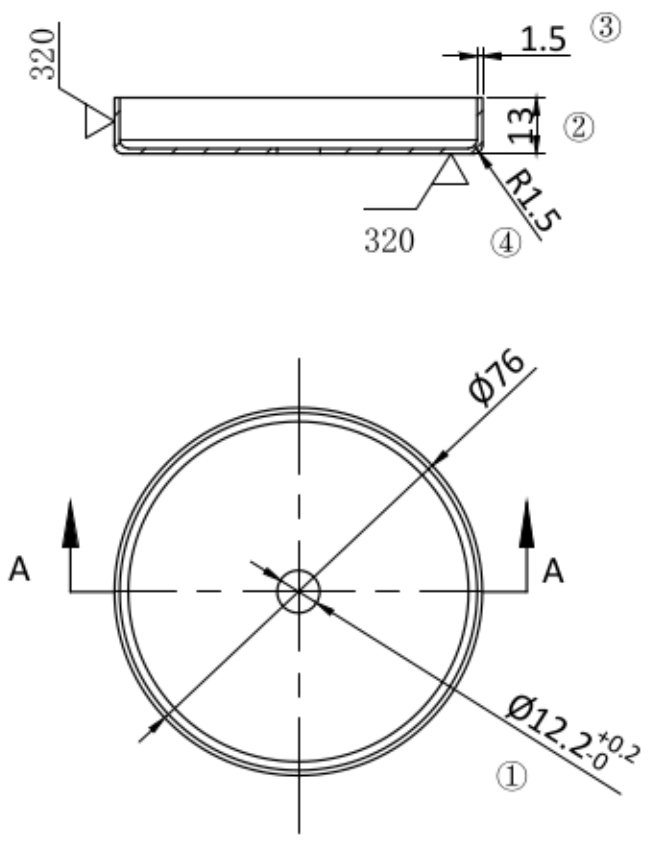

101.3270		1:2	A1
		SS316	