

Rz3.2

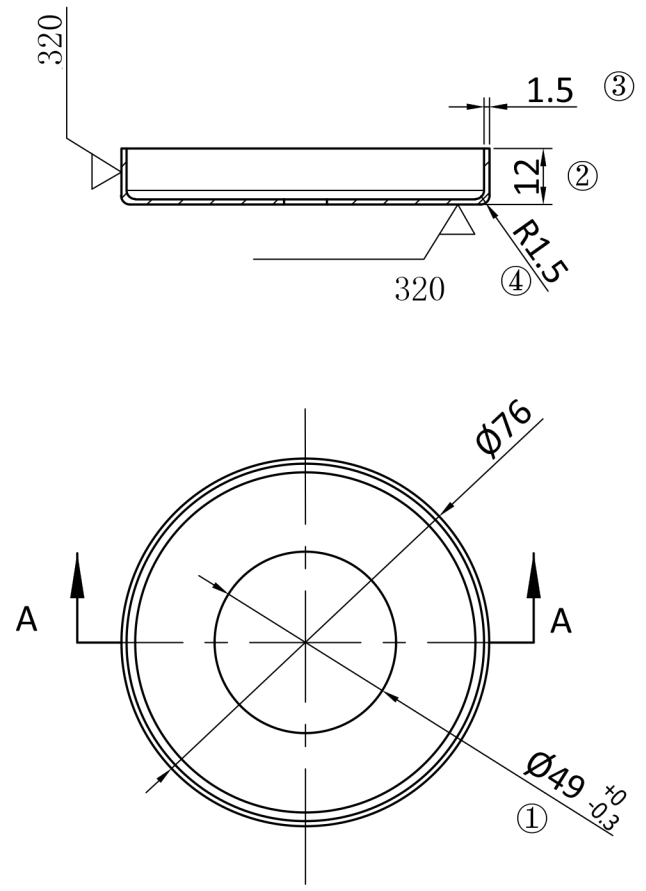

100.1330		1:2	A0
		SS304	
			2018.3.6