

Rz3.2

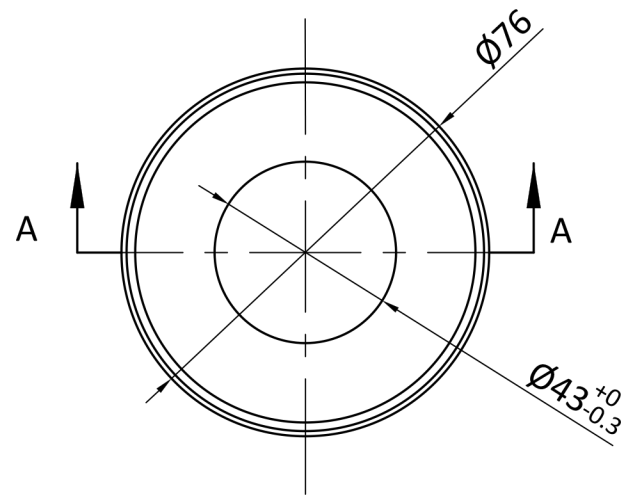
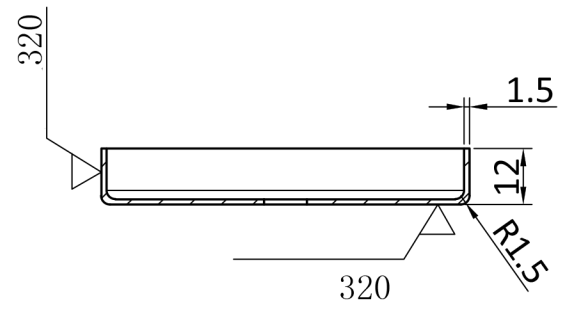

100.1325		1:2	A0
		SS304	
			2017.3.11
3001.76.12.52			