

Rz3.2

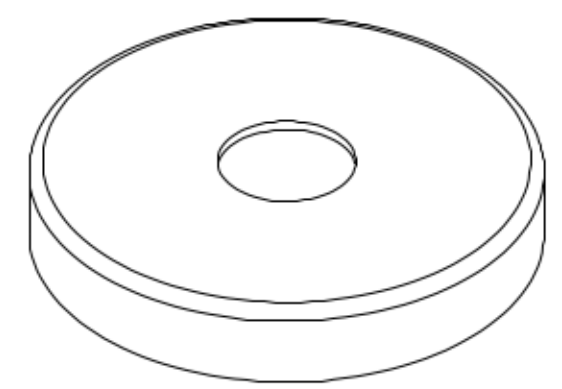
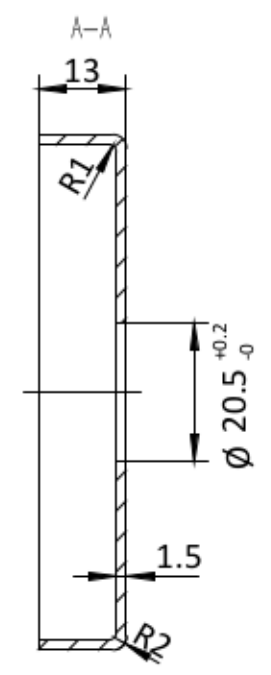
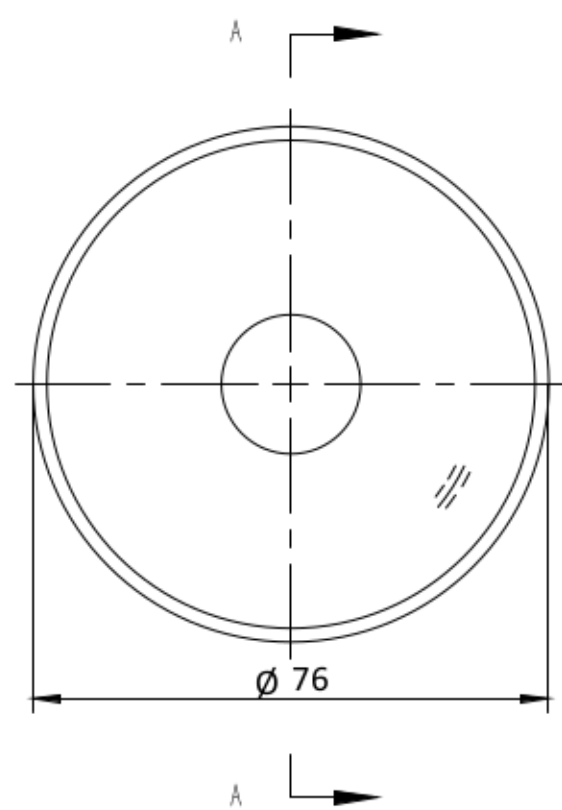

100.1310		1:1	A0
		SS304	
		0.08KG	