

Rz3.2

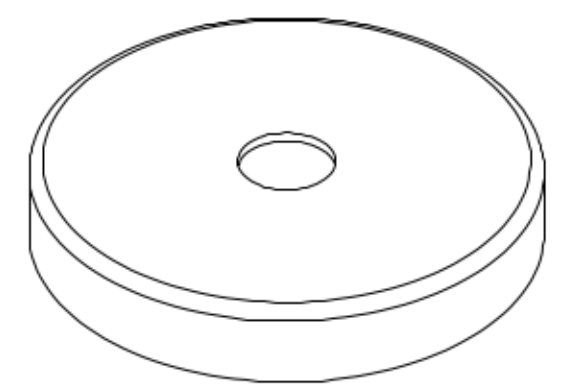
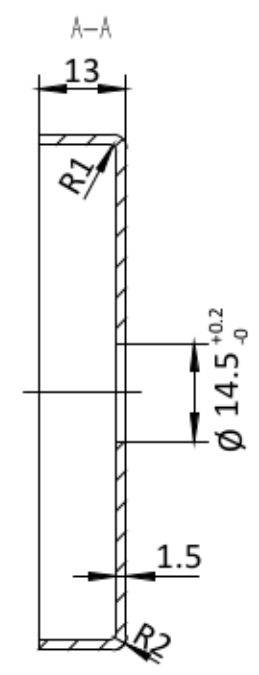
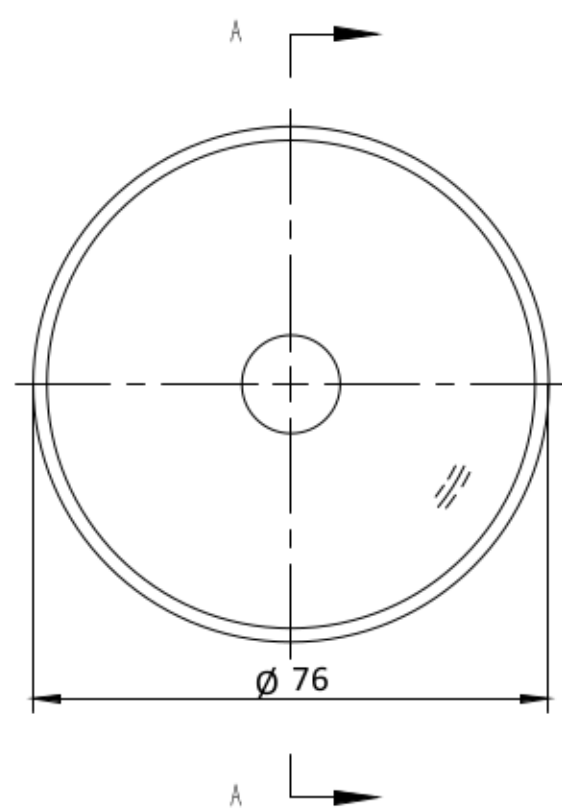

100.1305		1:1	A0
		SS304	
		0.083KG	