

Rz3.2

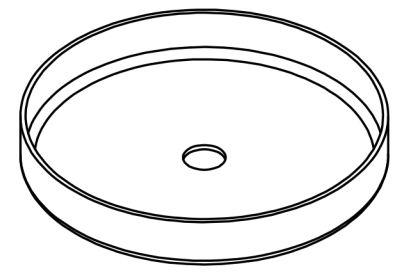
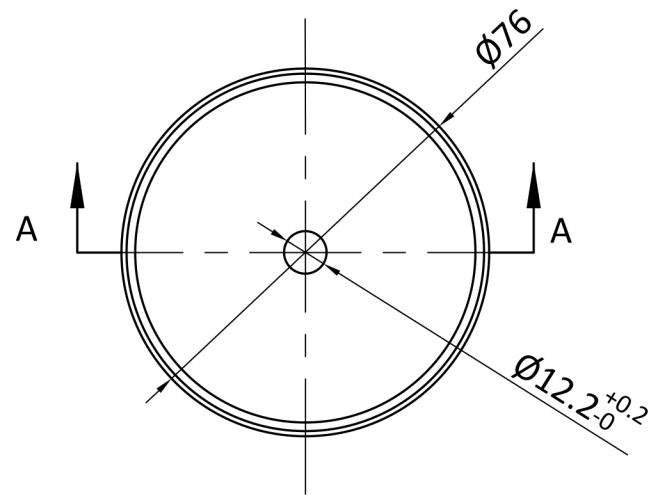
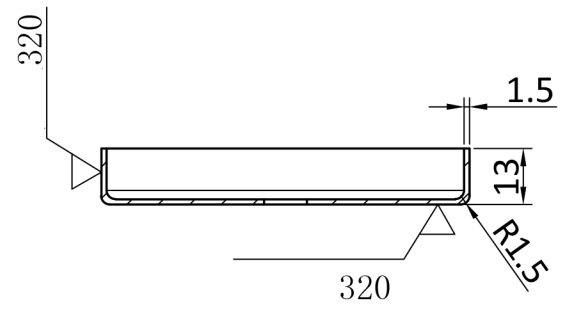

100.1300		1:2	A0
		SS304	
			2017.3.11
3001.76.12.12			