

Rz3.2

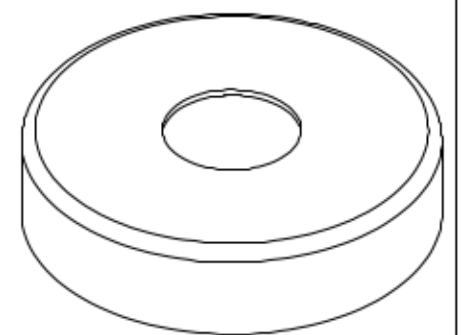

100.1295		2:1	A0
		SS304	
		0.04KG	