

Rz3.2

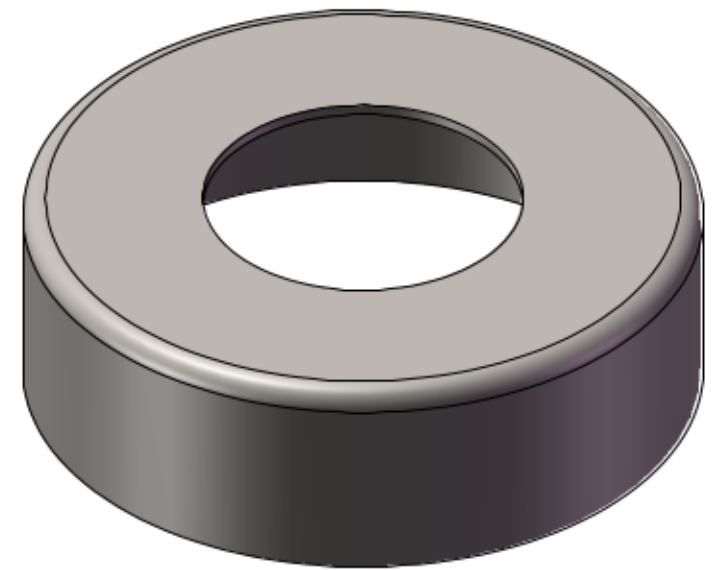
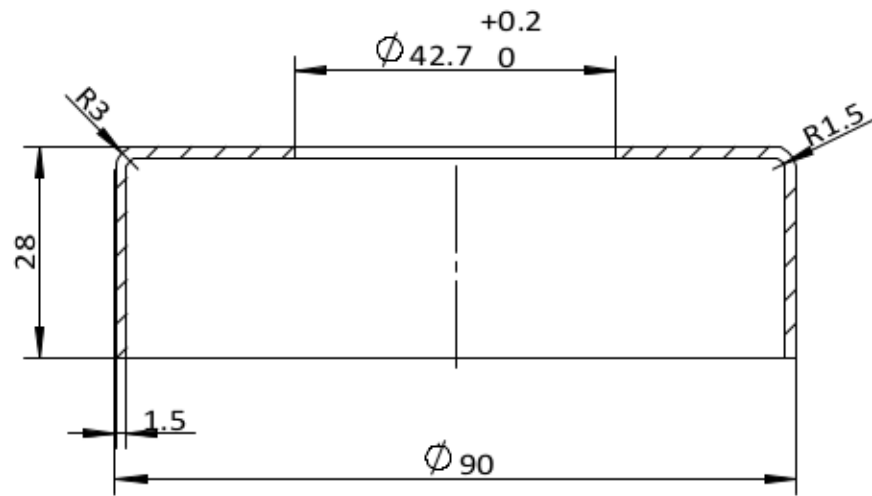

		1:1	A0
		SS304	
		143g	2020.7.6