

Rz3.2

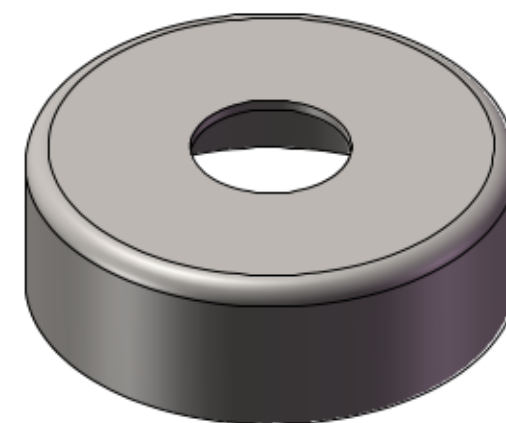
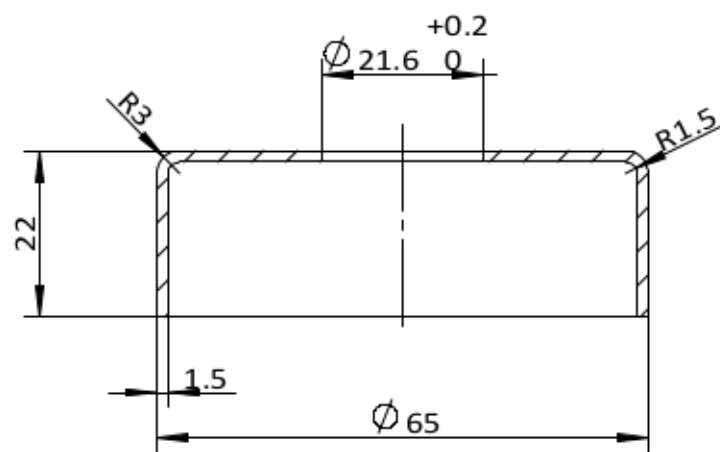

			1:1	A0
			SS304	
			82g	2020.7.6