

Rz3.2

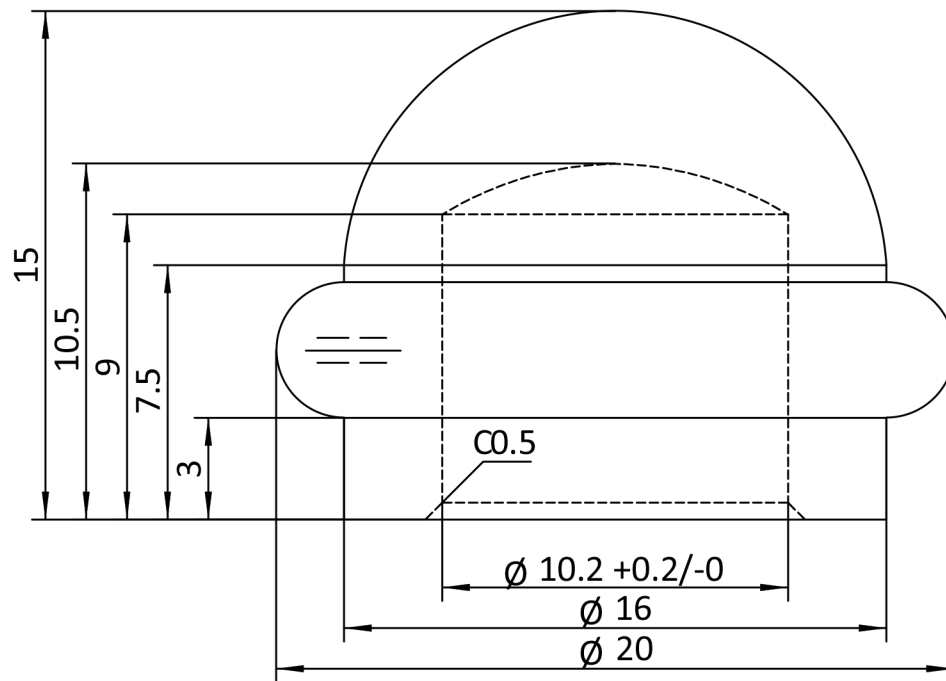

100.0710		2:1	A0
		SS304	
		16g	2019.10.16