

Rz3.2

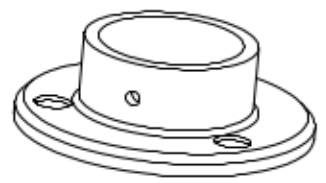
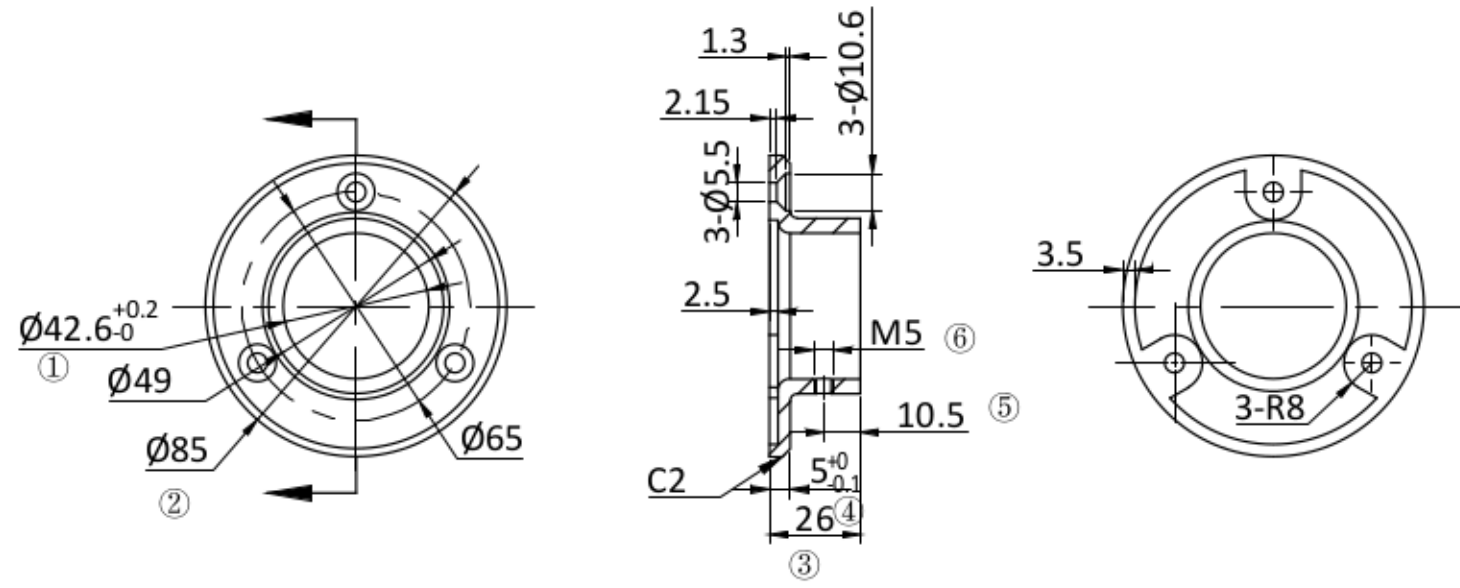

100.8426		1:2	A1
		SS316	