

Rz3.2

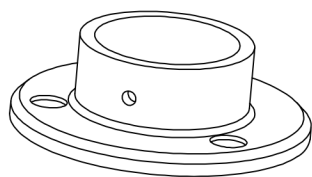
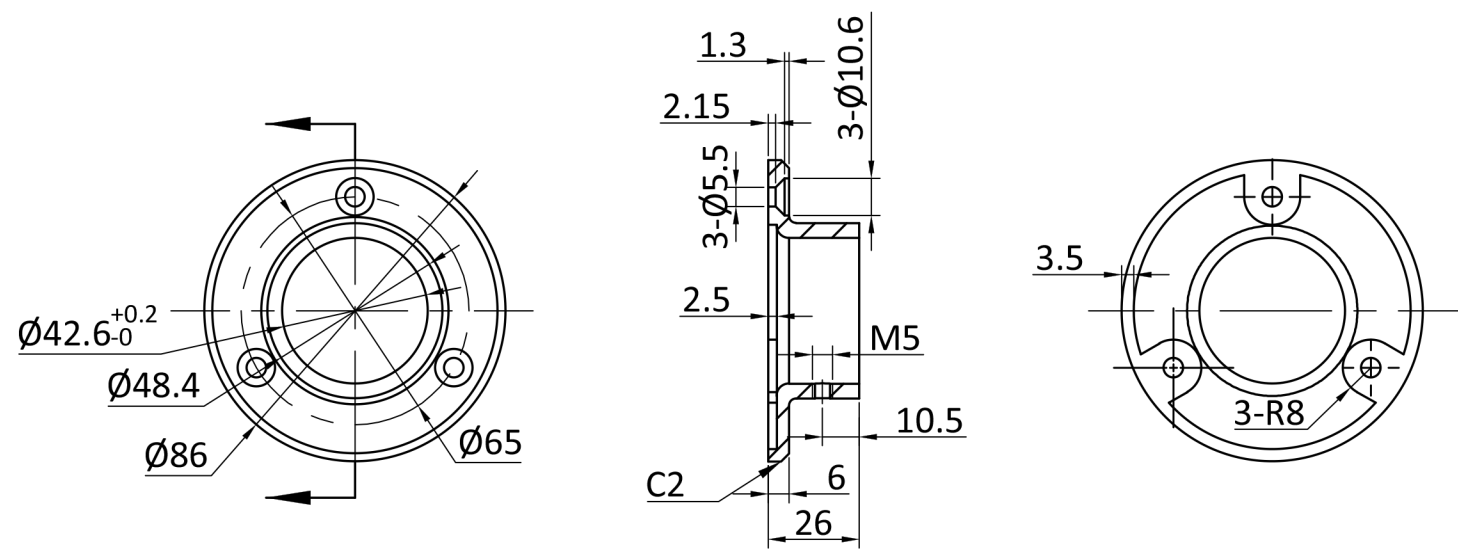

100.8425		1:2	A0
		SS304	
			2017.3.17
3100.42.012			